



HARRIS

Door and Millwork

EXTERIOR DOOR CATALOG





TABLE OF CONTENTS

HARRIS DOOR & MILLWORK

04-05 Get Inspired

06 HDM System

07 Plastpro Quality

08 Nova Series Doors

09 Nova Full Lite SDL

10 Nova 90 3/4 Lite Doors

11 Nova Onyx Doors

12 Craftsman Door

13 Craftsman SDL Options

14 Panel & Flush Doors

15 Slimline Specialty FG

16 Rustic Series

17 Au Courant Doors

18 Wood Fir Doors

19 SDL Options

20 Steel Doors

21 Retro Fit Doors

22 8/0 - Makeover Retro Textured Fiberglass

23 8/0 - Makeover Black Primed Fiberglass

24-25 Mahogany Doors

26 SDL Txt Mahogany Fiberglass Doors

27 Fiberglass SDL Options

28-29 Hardware

30-31 Multi Point Locks

32 S - Frame

33-34 Premium Door Frames

35 Standard Sizing Chart



For over 50 years, our family has been in the millwork business fostering a sense of community and home. Led by three generations of our family, we've evolved from a small local operation to a trusted brand, steadfastly upholding our core values while continuously adapting to meet our customers' needs. Every door we craft represents more than an entryway—it's an invitation to warmth, your cherished memories, and enhancing the character of your home.

Each product reflects our family's enduring legacy, capturing our unwavering commitment and the unique bond we share with our customers. Understanding the value of personal connections sets us apart. We're more than a brand; we're your neighbors, your friends, and partners in the journey of transforming houses into homes, with exceptional door and millwork products. As we look towards the future, we're deeply grateful for being part of your story. With anticipation, we continue our mission, welcoming more families home and carrying our family legacy forward for generations to come.

GET INSPIRED



WE HELP YOU BUILD YOUR DREAM ENTRY.

HDM System Includes:

- Long reach weatherstrip
- High efficiency dual bulb door bottom
- Corner seal pads
- End sill pad
- Two 2 1/4" long screws for hinges
- Rot resistant jambs & PVC brickmould
- Designed to give you a high performance door unit!
- 5-5/8" Composite Z-Series Sill



Easy Flip Operation

1. Ultimate Flip Lever Astragal

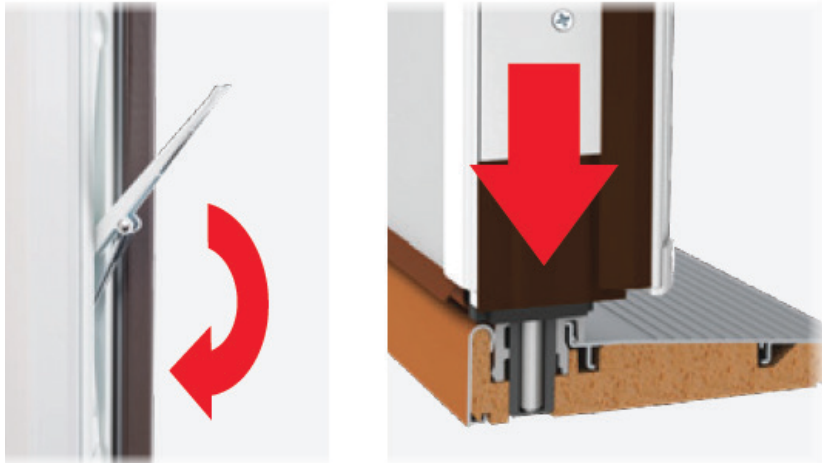
Enhanced performance and accessibility with effortless one-flip operation.



Aluminum & Wood Veneer Finishes

-  White
-  Clear Fir
-  Mahogany

Scan for video

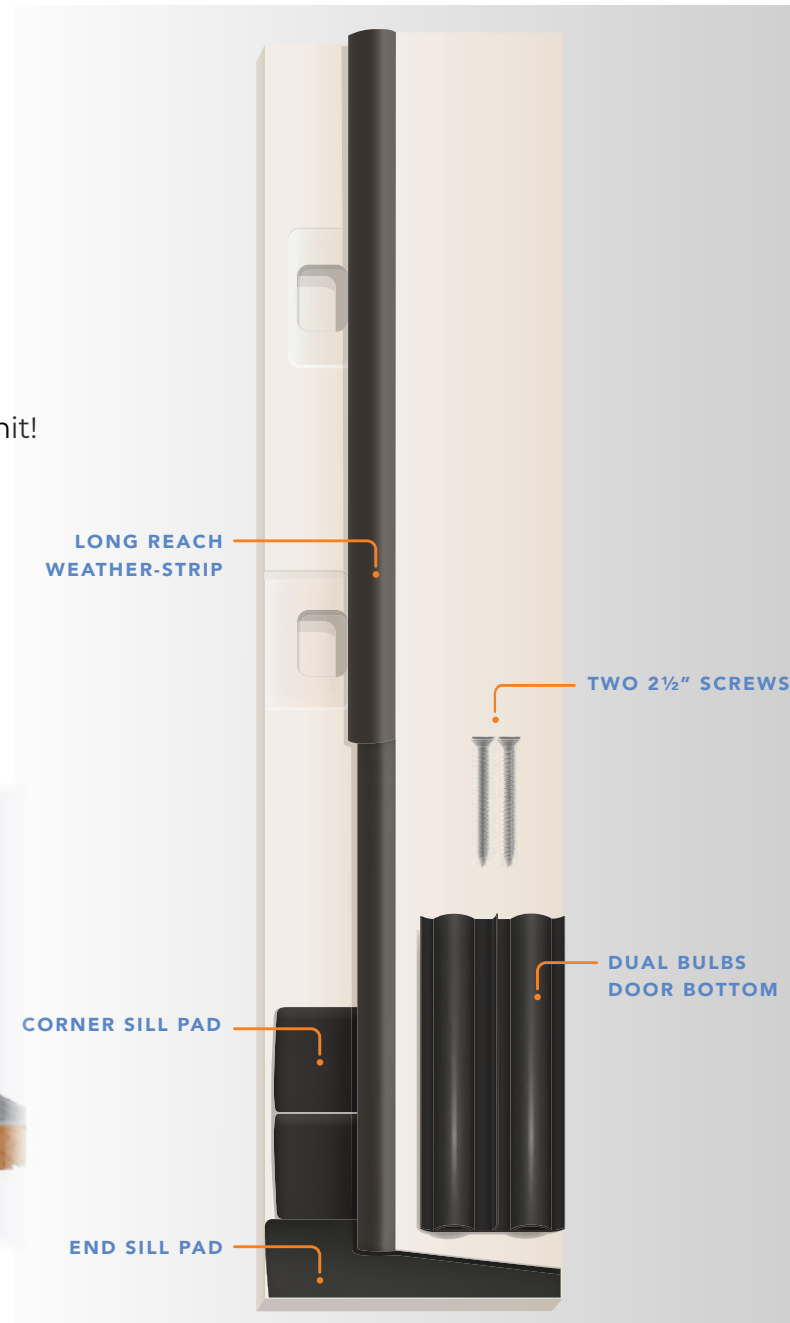

5-5/8" Composite Z-Series Bronze Sill

Patented Hydroshield Technology

Our exclusive HydroShield technology protects our doors against moisture and humidity infiltration by creating a fully composite barrier that encases and protects the door on all six sides. It prevents warping, delamination, corrosion, rotting, and the buildup of mold and mildew. Our doors with HydroShield technology used with our polyfiber floor frames create an enhanced, impenetrable entryway.

1. Fiberglass reinforced door skins

Our exclusive formula is measured precisely to ensure each skin is produced to the highest quality. With unlimited design options, customized panel configurations are possible. The skins require little maintenance and will not splinter, dent, warp, rot, or rust. They can be painted, stained, and we provide a variety of gaining options.

2. Full length composite stiles

Our full-length composite styles protect the door from external moisture to prevent warping or rotting. They have twice the screw-holding strength of wood.

3. Composite top & bottom rails

High strength composite top and bottom rails prevent moisture from seeping into the door and stops the buildup of mold.

4. Extended Lockblock

Plastpro's full length LVL allows any type of lock to be placed for increased security.

5. Polyurethane foam core

Our advanced CFC-free, high density, polyurethane foam core enhances the door's soundproofing capabilities and provides insulation up to six times greater than wood doors.

Backed by warranty

We are proud to offer one of the best warranties in the industry. Plastpro products are held to high standards. We stand behind our products and guarantee the best quality to meet your performance expectations.



Frame Decay Comparison



Plastpro PF Door Frame



Traditional Wood Frame

Nova 90

Our Nova series features direct glazed glass that creates a seamless and elegant design. The large pane glass allows the most amount of light into your home. The Nova 90 comes in a shaker profile and is available in brushed smooth finish.

Features & Benefits

1. Composite Stile Cap

2. Full Length LVL

(Hinge & strike side, for extra rigidity)

3. Wood blocking

(For structural support in HVHZ impact models)

4. Steel Beam

(Hinge & strike side, for extra rigidity in all 8'0" and HVHZ impact models)

5. Insulated 1" Glass

6. Compression Molded Fiberglass Skin

7. Brush Finished Texture

8. Integrally Molded Glass Top

9. High Density Polyurethane Foam

10. ADA Compliant Bottom Rail

11. Composite Bottom Rail

12. Can be stained or painted

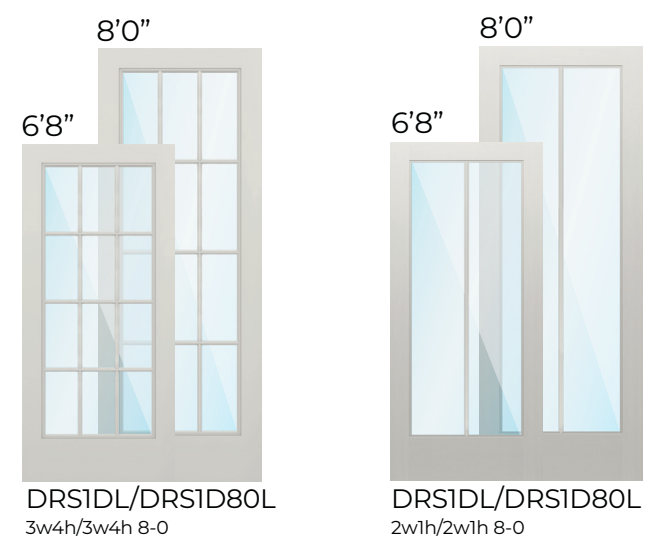
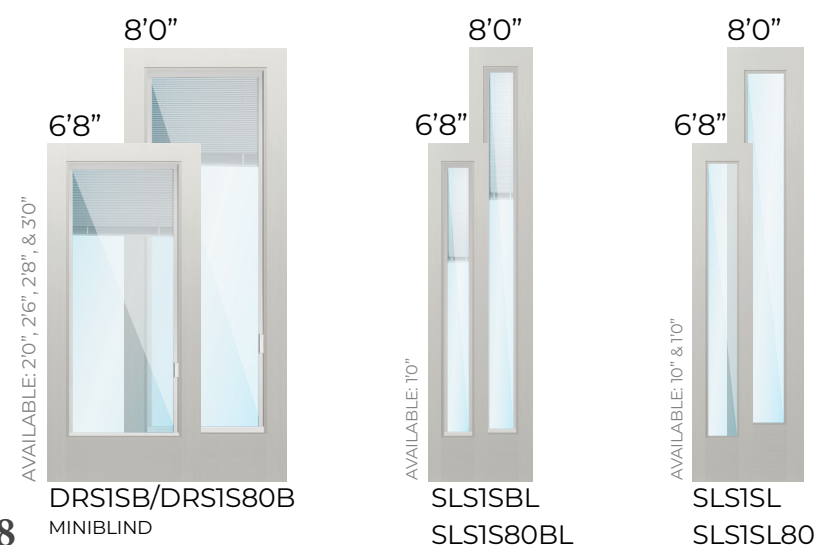
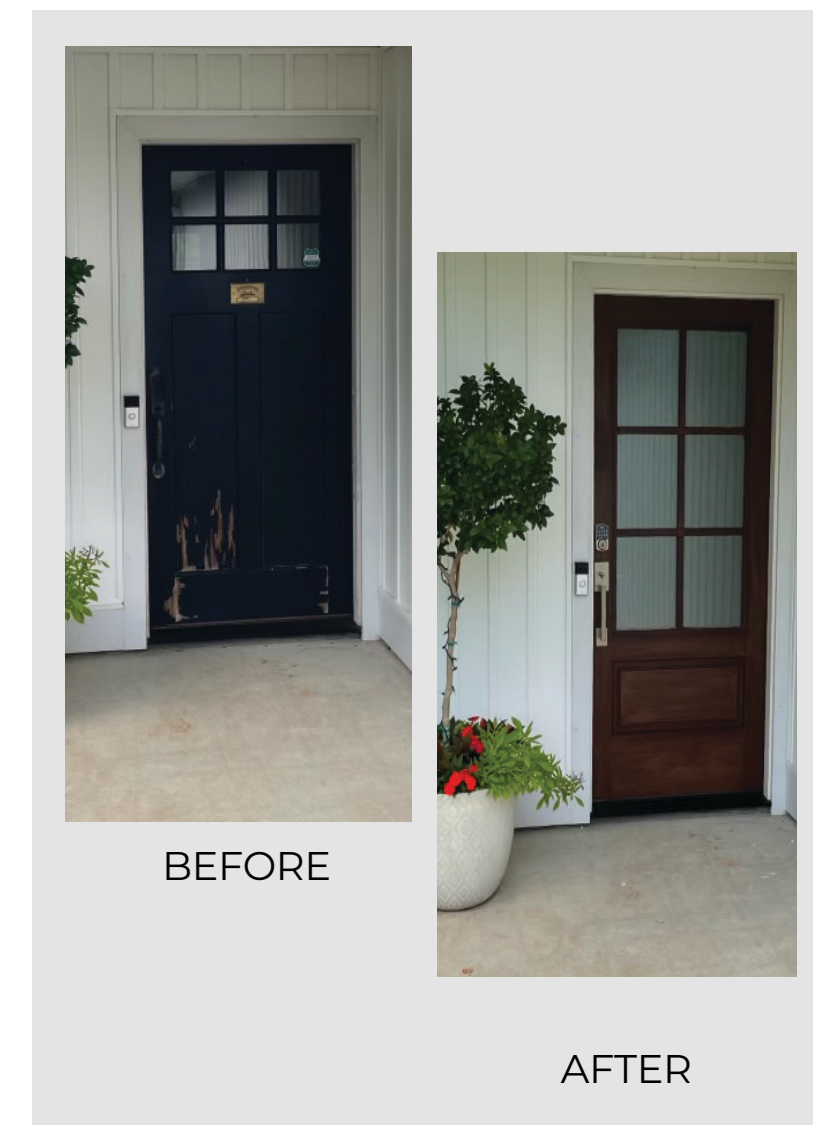
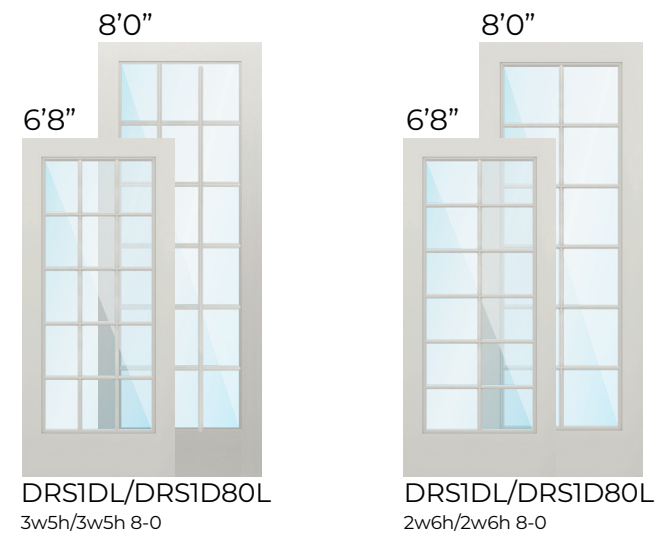
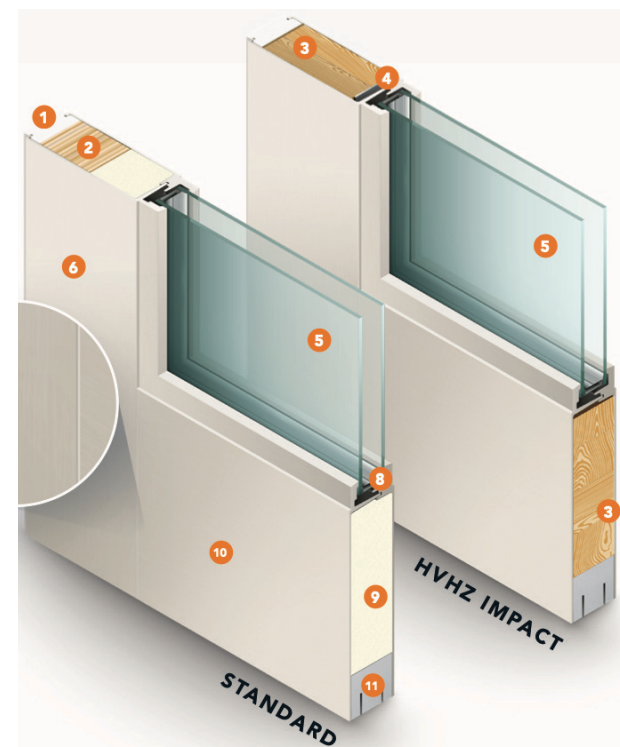
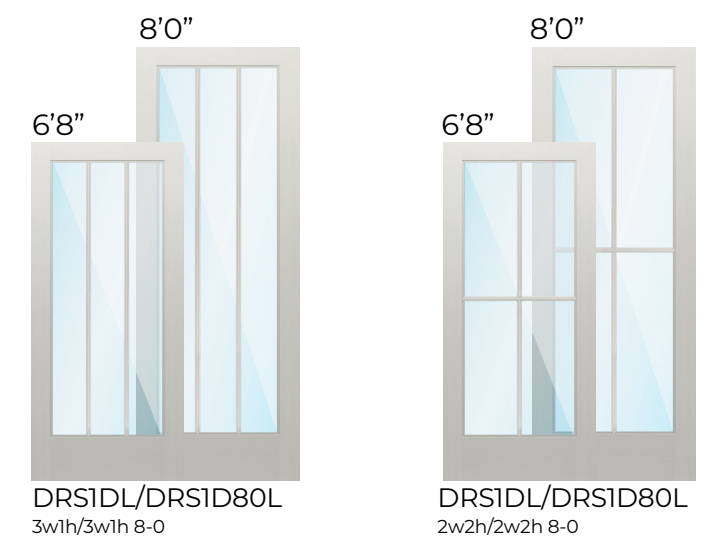
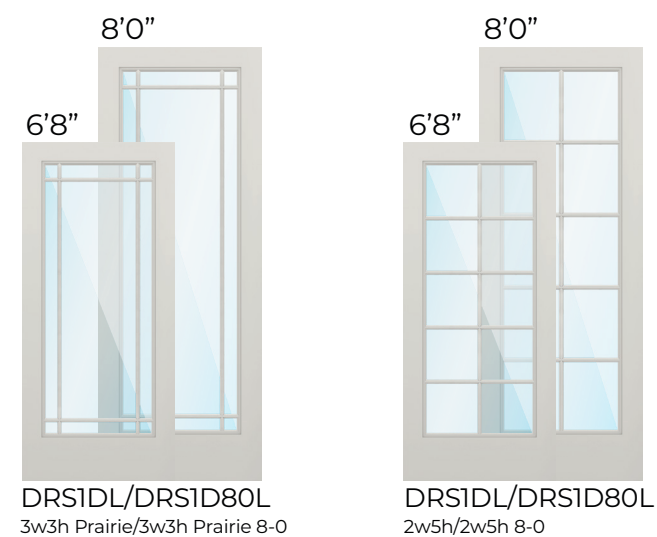
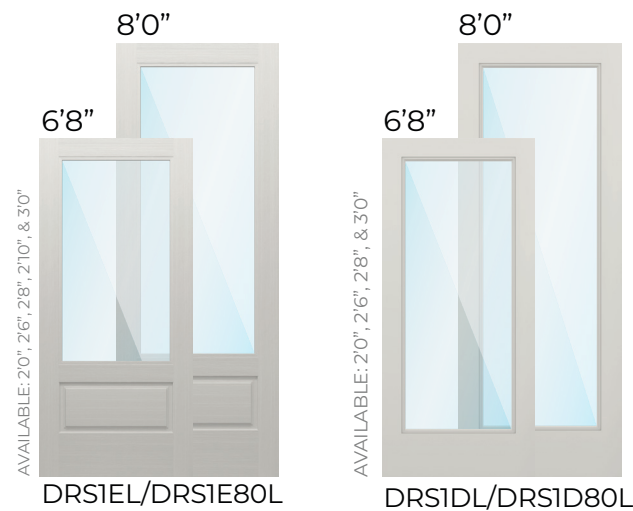

AVAILABLE: 2'0", 2'6", 2'8", & 3'0"

6'8" & 8'0" 6'8" & 8'0" 6'8" & 8'0" 6'8" & 8'0" 6'8" & 8'0" 6'8" & 8'0"



DRSEL
DRSEL80
6'8" & 8'0"

DRSIEL
DRSIEL80
2w1h/2w1h 8-0
6'8" & 8'0"

DRSIEL
DRSIEL80
3w2h/3w2h 8-0
6'8" & 8'0"

DRSIEL
DRSIEL80
2w2h/2w2h 8-0
6'8" & 8'0"

DRSIEL
DRSIEL80
2w3h/2w3h 8-0
6'8" & 8'0"

DRSIEL
DRSIEL80
3w6h/3w6h 8-0
Queen Anne
6'8" & 8'0"

6'8" & 8'0" 6'8" & 8'0" 6'8" & 8'0" 6'8" & 8'0"



DRSIEL
DRSIEL80
3w3h/3w3h 8-0
Prairie
6'8" & 8'0"

DRSIEL
DRSIEL80
1w4h/1w4h 8-0
6'8" & 8'0"

DRSIDL
DRSIDL80
2w5h/2w5h 8-0
6'8" & 8'0"

DRSIEL
DRSIEL80
3w3h/3w3h 8-0
6'8" & 8'0"

AVAILABLE: 2'6", 2'8", & 3'0"

- AVAILABLE IN:**
- Double-Insulated
 - Tempered
 - Low-E
 - GBG
 - Mini Blind
 - Flemish

AVAILABLE IN SIZES: 2/6, 2/8, & 3/0, WIDTHS: 6/8 & 8/0

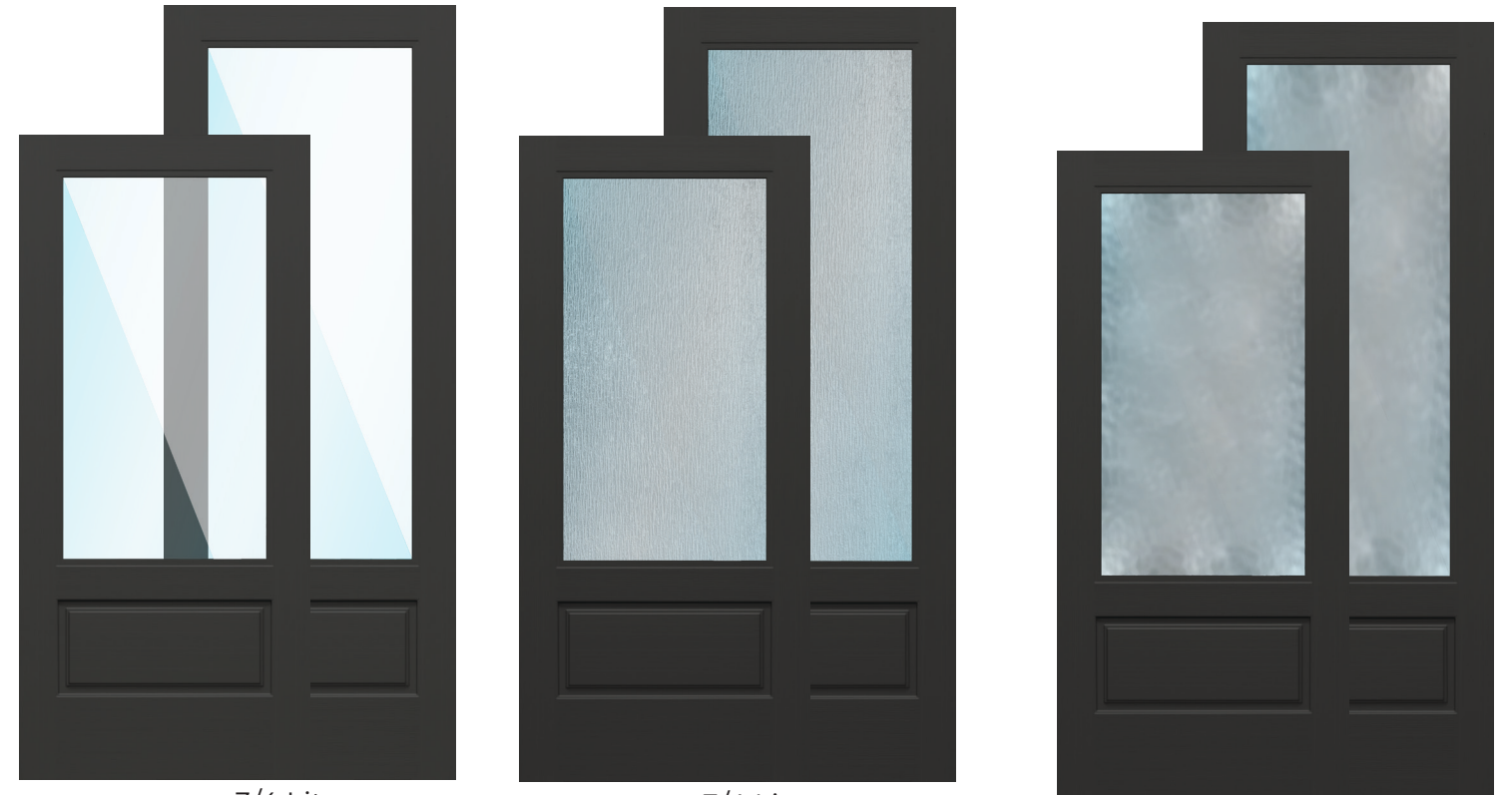

3/4 Lite
Clear Low E Glass

3/4 Lite
Rain Low E Glass

3/4 Lite
Flemish Low E Glass
Also Available in White



Full View
Clear Low E Glass



Full View 3/4 Lite
Sizes 10" & 12"

SIDELITE GLASS OPTIONS



Low-E

RAIN

FLEMISH

One Lite Series Doors

Featuring a flush glazed glass with removable stop to allow glass to be switched without changing the door.



DRS12
DRS12
2W2H
6'8"

DRS12
DRS12
2w3h
6'8"

DRS12
DRS12
3w3h Prairie
6'8"

DRM13/DRM1380
8'0"

SLM13/SLM1380
8'0"

AVAILABLE: 2'8" & 3'0"



CRAFTSMAN DOORS

CRAFTSMAN SDL OPTIONS



AVAILABLE: 3'0"

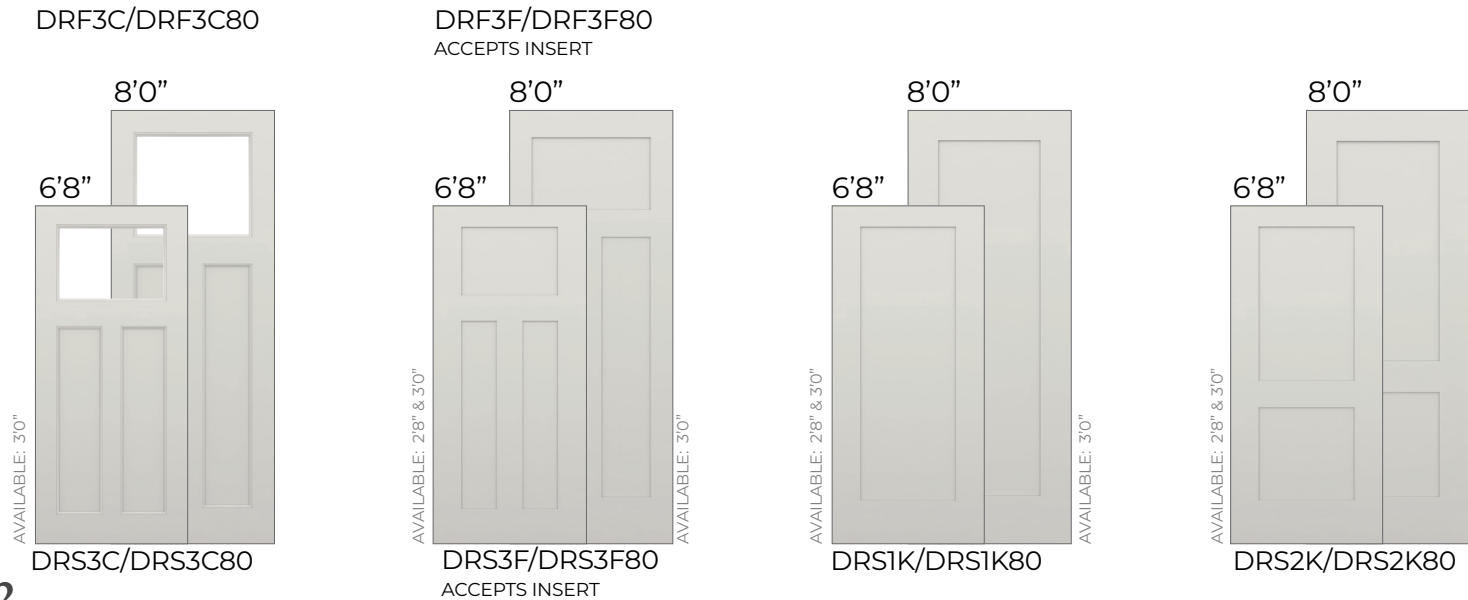



DRS2B/DRS2B80

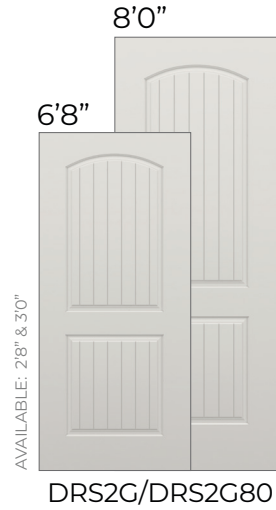

DRS2G/DRS2G80



DRS60/DRS6080

*Available in TXT Fiberglass



DRS29/DRS2980

*Available in TXT Fiberglass



DRS61/DRS6170/DRS6180

*Available in TXT Fiberglass

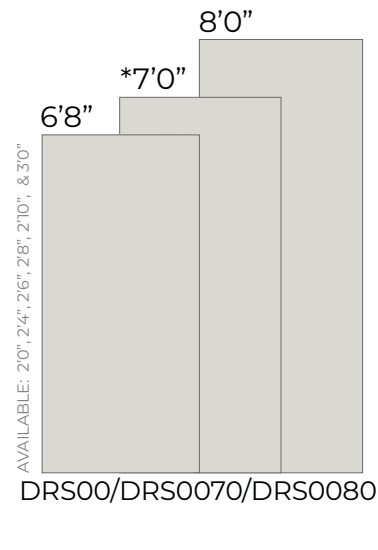

DRS00/DRS0070/DRS0080

*7'0 AVAILABLE: 3'0" ONLY



DRS2D



Available in: 2/6, 2/8, & 3/0 in 6/8 & 8/0

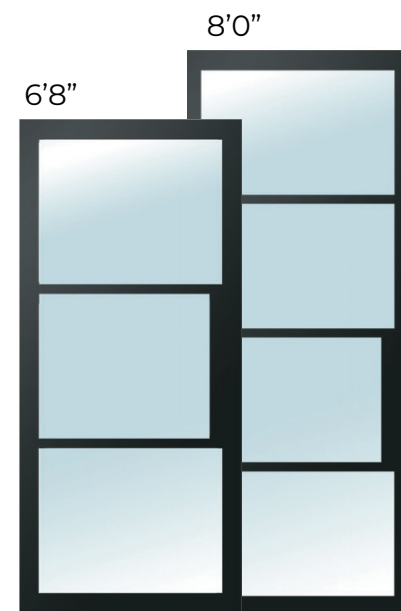

3LT Slimline Low-E

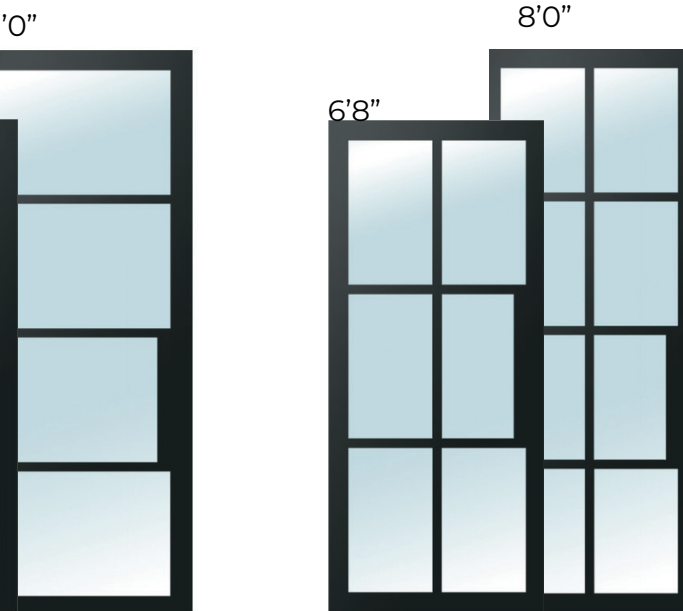

4LT Slimline Low-E

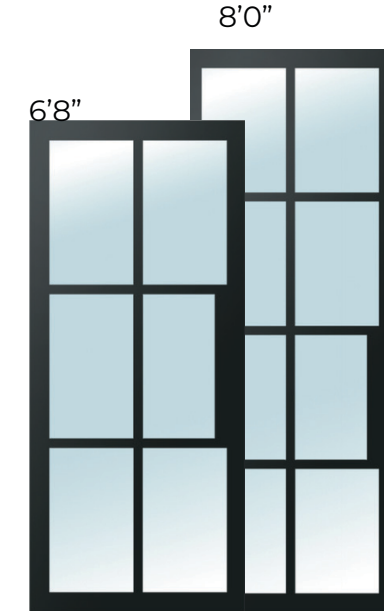

6LT Slimline Low-E



8LT Slimline Low-E

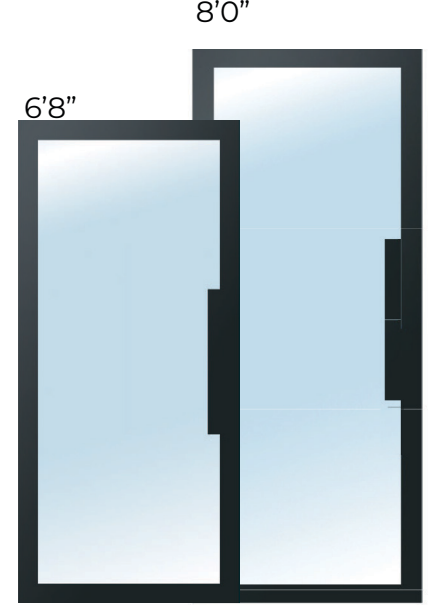

1LT Slimline Low-E
3/6 & 8/0 in Stock



3LT Sidelite No Lock Block

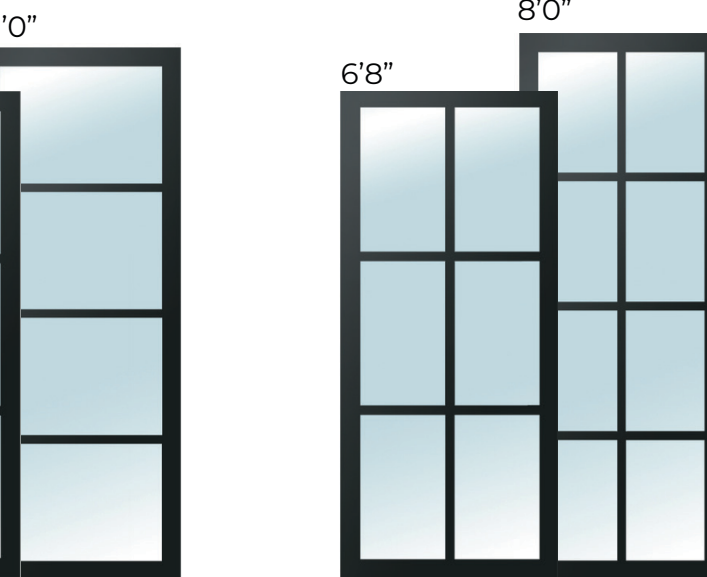

4LT Sidelite No Lock Block

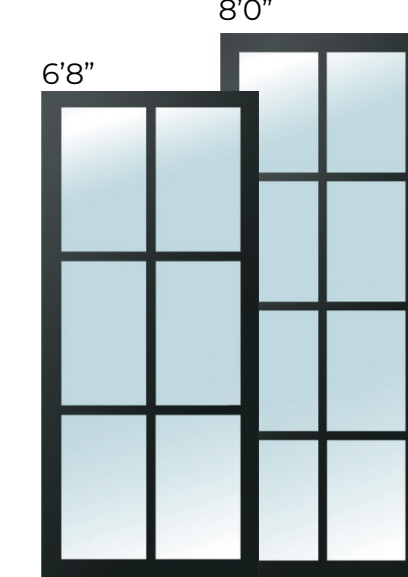

6LT Sidelite No Lock Block



8LT Sidelite No Lock Block

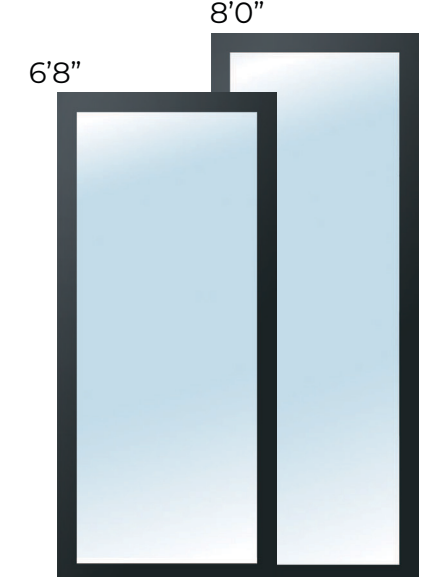

1LT Sidelite No Lock Block

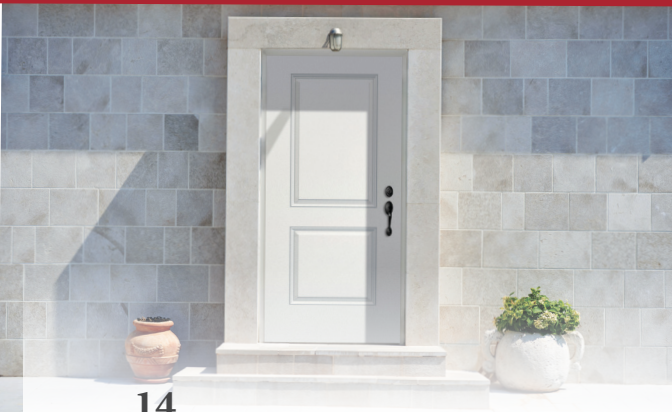

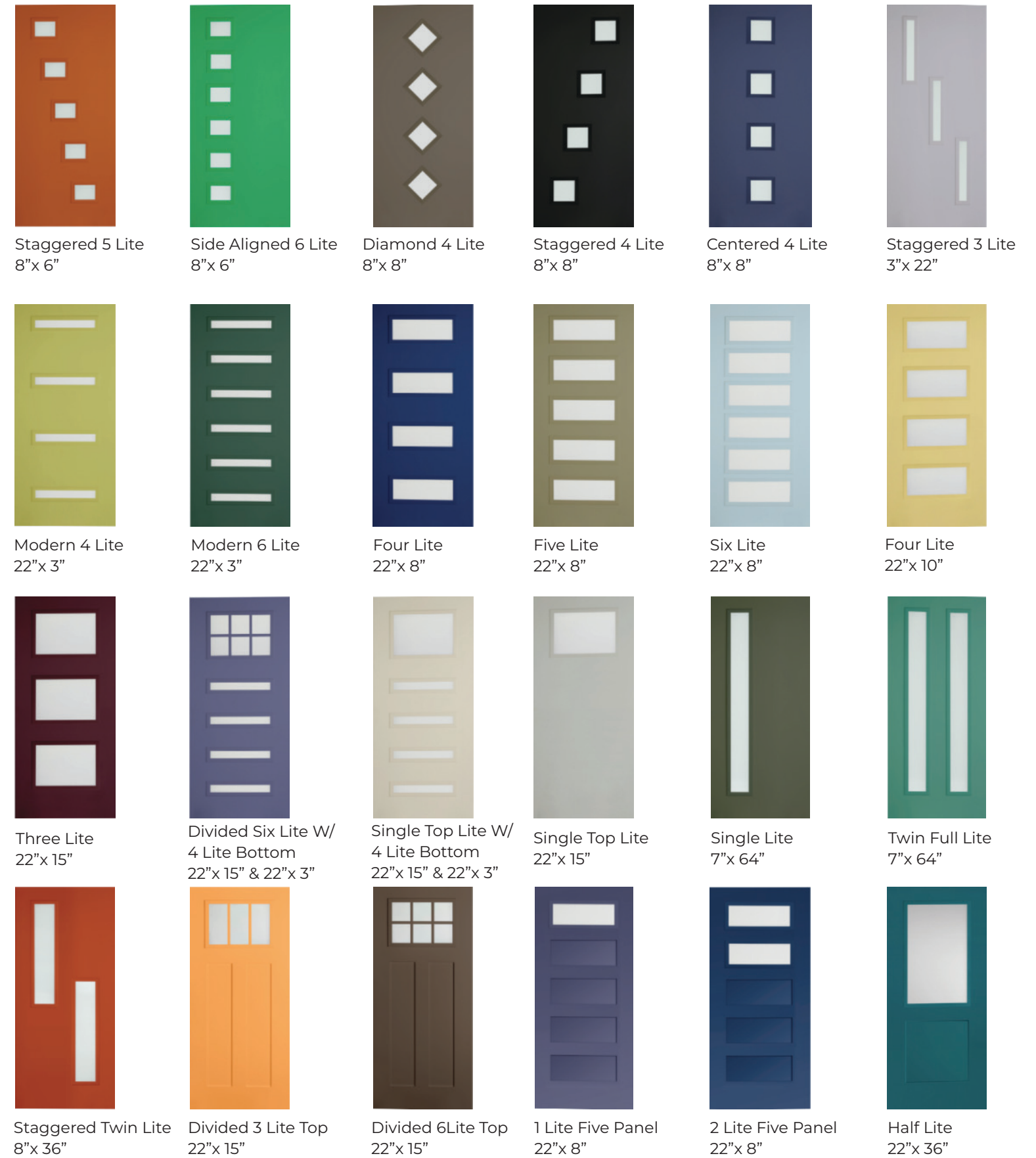

IN-STOCK FIR WOOD DOORS

SDL OPTIONS

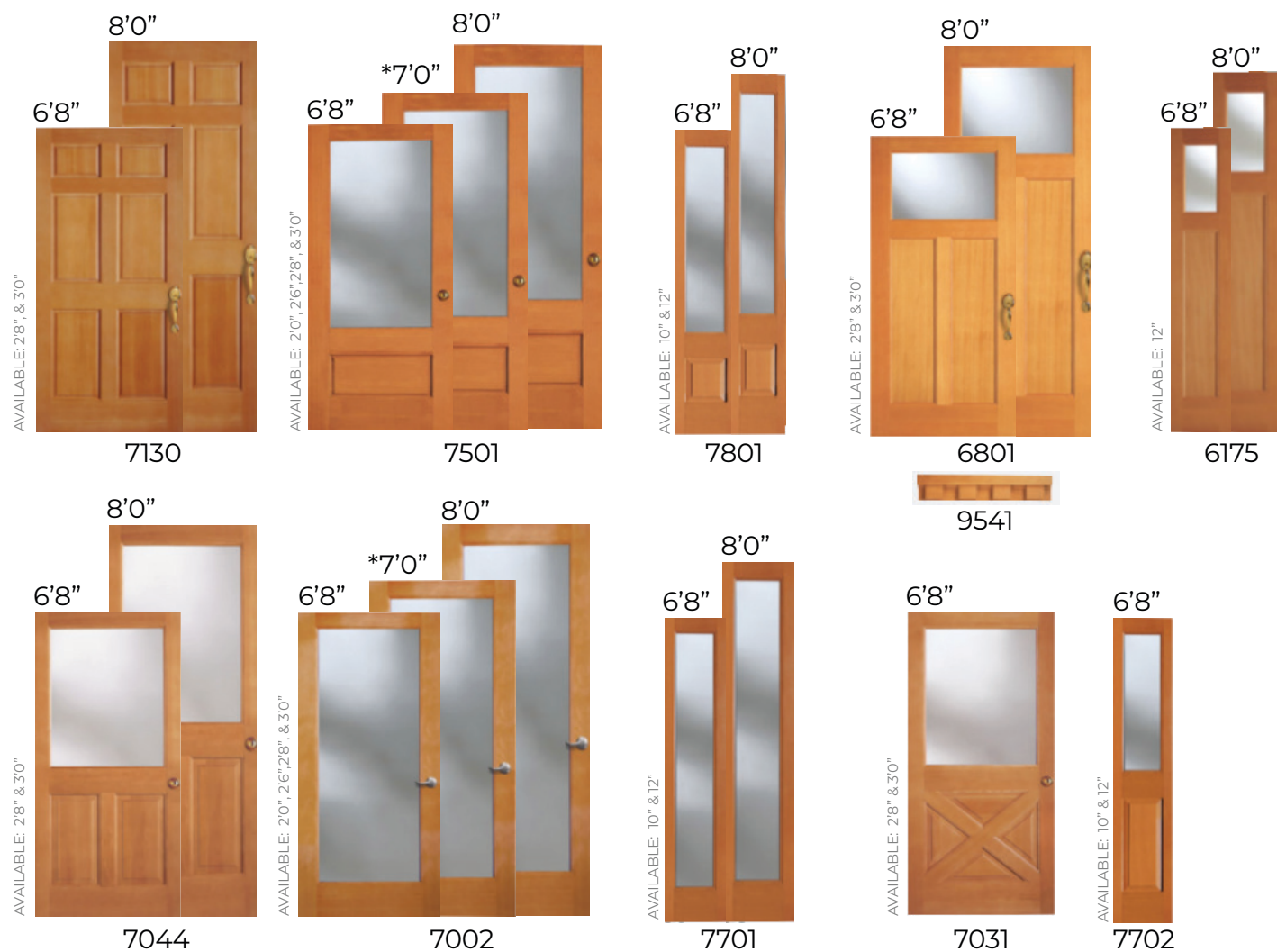

*Can be painted or stained

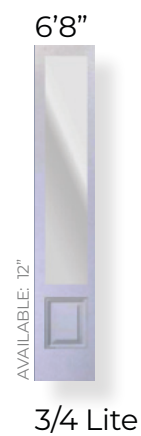
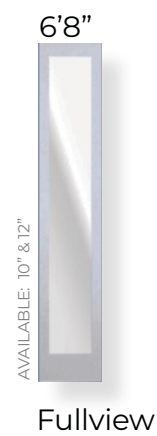
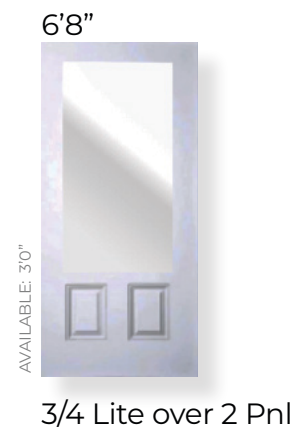

Before



After

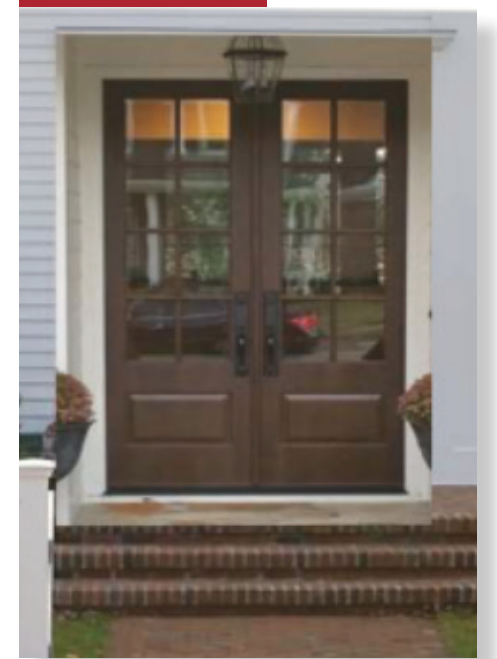

*Replaces 10" x 3-0 x 10" with 10" Transom
12" x 3-0 x 12" with 12" Transom
Unit Size 60 5/8" x 93 1/4"*



4LT Square Top - Low E Glass



4LT Square Top - Flemish Glass



Square Top - Diamond Light



6LT Square Top - Low E Glass



6LT Square Top - Flemish Glass



6LT Common Arch -Flemish Glass

Elevate Your Home
With Black Fiberglass!



6LT SDL - Clear Low-E Glass



6LT SDL - Flemish Glass

Replaces 10" x 3-0 x 10" with 10" Transom
12" x 3-0 x 12" with 12" Transom
Unit Size 60 5/8" x 93 1/4"



3/0 x 6/8 With 2 x 10" Sidelites and 10" Transom



8/0 Retrofit Double Door
Actual Unit Size 60 1/2" x 93 1/4"

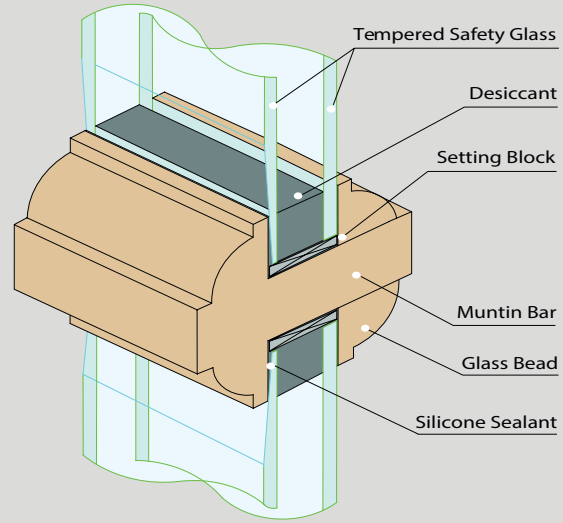

TDL Muntin Bar at Glass

The **True Divided Lite (TDL) Collection** makes a classic addition to any home, complementing a wide range of architectural styles. 1-3/4" thick TDL Collection doors feature individual panes of double insulated, clear, "Low-E" energy efficient beveled glass for beauty, strength and security. True Divided Lite doors have engineered stiles and rails that virtually eliminates warping.



6 LITE TDL ARCH TOP
AVAILABLE: 5'0", 5'4", & 6'0" in 8/0 Height



3/4 6LT TDL Low-E Beveled Glass



1 LT Low-E



3/4 6LT TDL Arch Top Low-E



Craftsman TDL 6LT

AVAILABLE: 2'6", 2'8", & 3'0" in Heights 6/8 & 8/0

Traditional Privacy Glass Options:

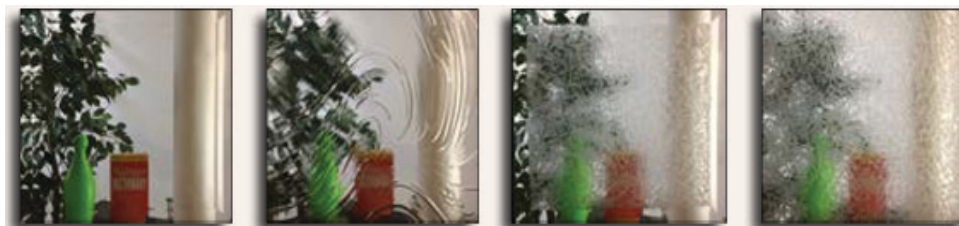

Clear Bevel Privacy Rating: 1 Baroque Privacy Rating: 2 Gluechip Bevel Privacy Rating: 3 Gluechip Privacy Rating: 4

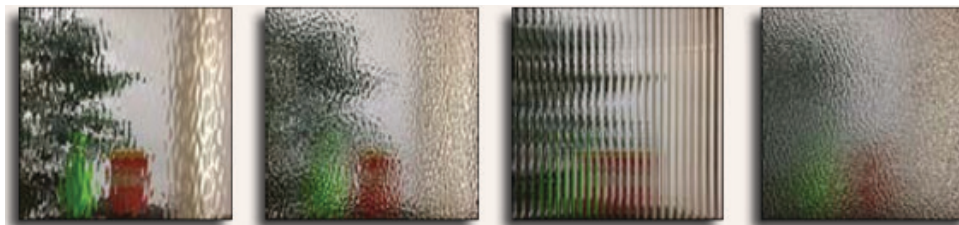

Water Privacy Rating: 5 Hammered Privacy Rating: 6 Reeded Privacy Rating: 7 Granite Privacy Rating: 8



3LT Contemporary



5LT Contemporary



6LT Contemporary



7 Pnl Contemporary

AVAILABLE: 3'0" x 8/0 Only

3 Week Lead Time

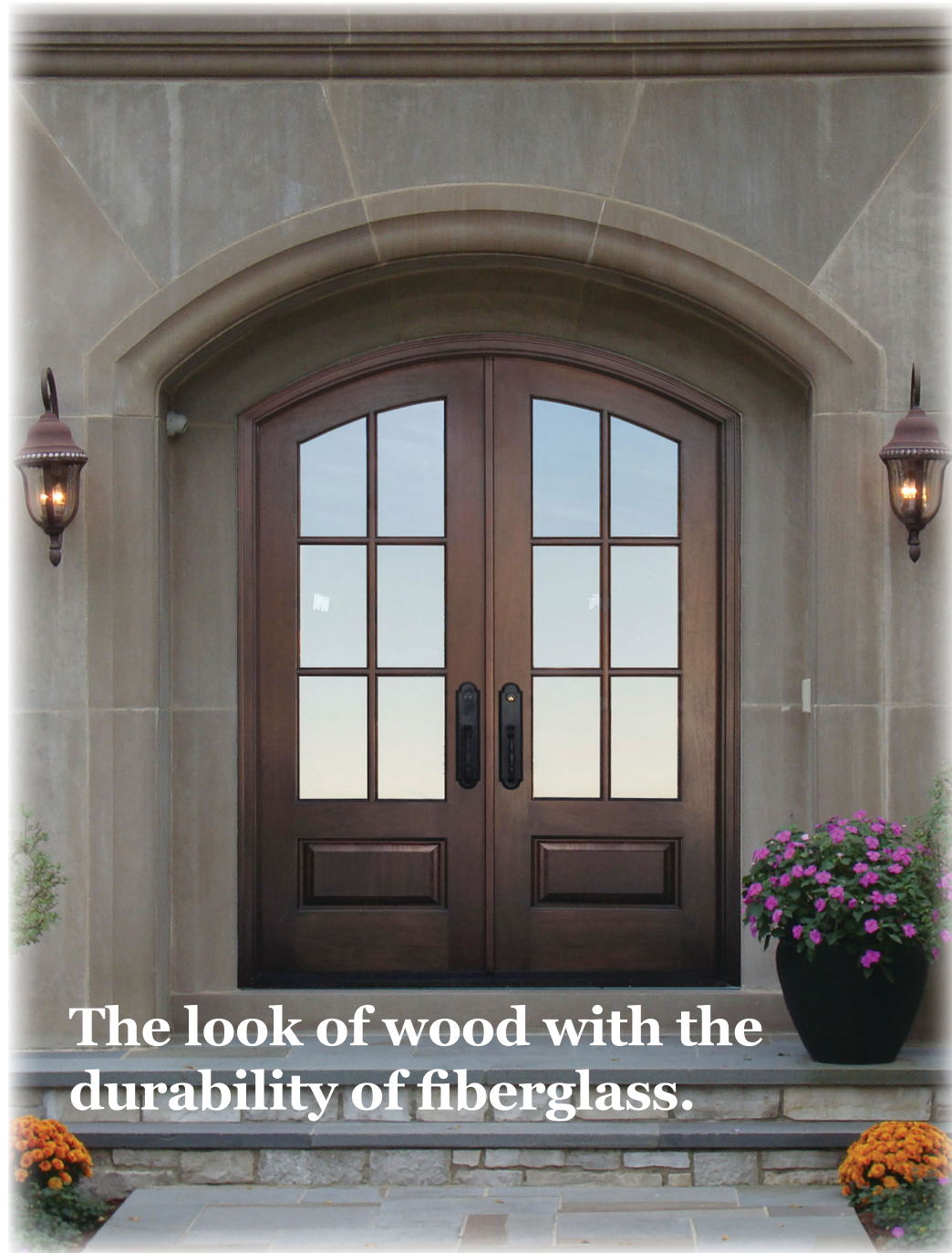

The look of wood with the durability of fiberglass.

Available In: 5'0" x 8'0", 6'0" x 8'0"
Integral Molded
Fiberglass SDL Grilles
with Internal Spacers



6LT Arch Top SDL -
Flemish Glass



6LT Arch Top SDL -
Clear Low-E Glass

Ogee Profile

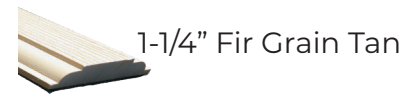
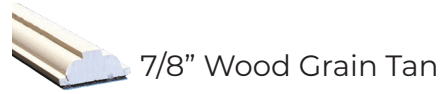

Putty Profile

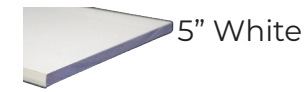
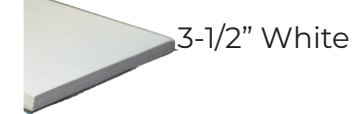

Wood SDL

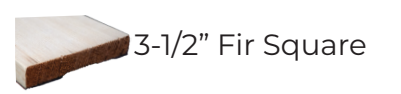
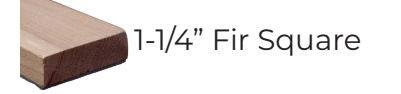
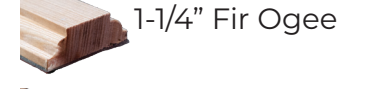

Personalize
Your Door
With A Custom
SDL Pattern.





Antique Brass



Antique Nickel



Bright Brass



Flat Black



Oil-Rubbed Bronze

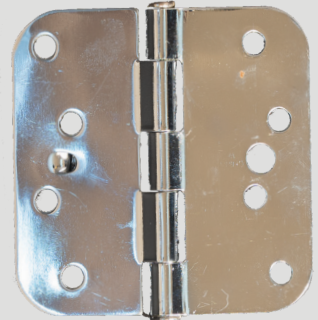

Polished Chrome



Satin Brass



Satin Nickel

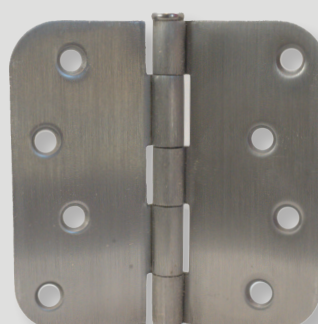

Stainless Steel



White Primed



Zinc Brass

		Ball Bearing	NRP	Spring
US2D	Zinc	X		X
US3	Bright Brass	X		X
US5	Antique Brass	X		X
US10B	Oil-Rubbed Bronze	X	X	X
US15	Satin Nickel	X	X	X
US15A	Antique Nickel	X		
US26	Polished Chrome	X		X
USP	Flat Black	X	X	X
USS	Stainless Steel	X		

6/8 Hinge Locations

- 1st Hinge 6-7/16"
- 2nd Hinge 37-5/8"
- 3rd Hinge 68-13/16"

- Lock Location 43-11/16"
- Deadbolt 5-1/2" OC

8/0 Hinge Locations

- 1st Hinge 6-7/16"
- 2nd Hinge 32-9/16"
- 3rd Hinge 58-11/16"
- 4th Hinge 84-13/16"

- Lock Location 59-11/16"
- Deadbolt 5-1/2" OC

Works with a wide variety of standard hardware, including electronic deadbolts.

Use of multi-point locks has been limited due to high cost, difficult installation and operation, and the limitations of dedicated handle set hardware required for each lock offering. Not so with PanoLock+.

An innovative system of adapters lets PanoLock+ work with a wide variety of off-the-shelf hardware (both standard and smart locks). Brands include Schalge, Kwikset, and more.

A. Tapered bolt, unlike other locks that tend to catch, PanoLock+'s tapered bolts engage easily, even when the door is out of alignment.

B. Adjustable roller strike. Rollers lower operating force, allowing the tapered bolt to gently snug the door panel against the weatherstrip.

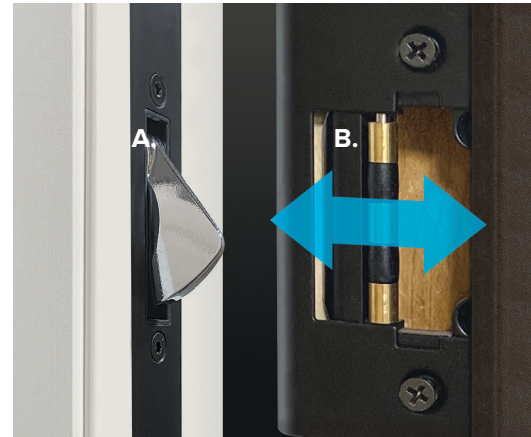

Adjustable Strike Plate Finishes



Black



Stainless Steel

Faceplate Finishes



Bronze Anodized



Brushed Clear Anodized

Sizes: 6/8 & 8/0



Easy to live with.

A simple turn of the deadbolt operates both tapered bolts smoothly and the handle-set operates the handle set latch. Three points of secure contact. PanoLock+ is easy to live with, even after years of use.

Easy to work with.

PanoLock+ is flexible. Handing and swing can be set in the shop, reducing SKUs.

- No dedicated hardware required
- No need for dedicated panels
- No difficult installation
- No expensive templates

Tested and proven.

PanoLock+ has been extensively tested and proven to perform, even in severe conditions. PanoLock+ withstood winds up to 200 mph in structural testing.

- Operating torque/force tested as low as 2 in/lbs with selected handle sets
- Durability cycle testing passes 100,000 cycles
- Air filtration and exfiltration testes to A2
- Water infiltration and exfiltration tested DP60 with Z-articulating cap sill
- Impact/dorced entry resistance tested grade 40



Scan for video

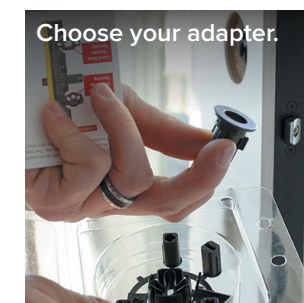

PanoLock+ Square Adapter

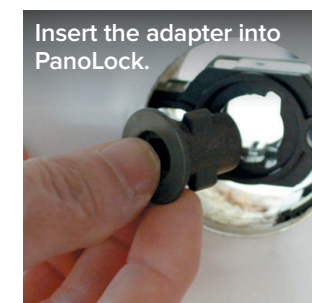

PanoLock+ can work with a thumb press, lever, or knob.

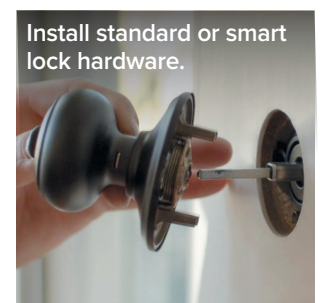

The S-Frame is a low-profile frame that provides a modern look without sacrificing durability and reliability.

Privacy Glass Options

*Special order



Pure



Rainglass

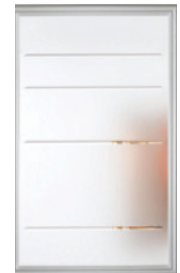

Zenith



Chinchilla



Frosted



Oceana

Features & Benefits

1. Available in white or tan
2. Injection molded offers a smooth texture
3. Extruded vinyl S-frame has a woodgrain texture
4. Dry applied sealant eliminates squeeze out
5. Idealseal dry sealant prevents dirt adhesion
6. Built to resist warping

Frame Size Options

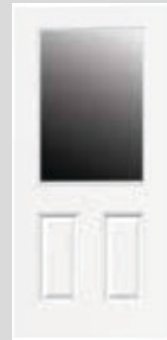

22"x 36"

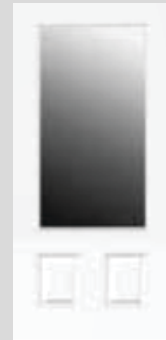

22" x 48"



20" x 64"
22" x 64"



22"x 15 1/4"
20"x 15 1/4"



7"x 64"



8"x 48"



Exterior Door Polyfiber Frames

Plastpro's Polyfiber (PF) Door Frames are an innovative new alternative to traditional door jambs. Our uniquely formulated door frame combines the beauty of wood, but requires less maintenance and has a longer life span. The material is durable, long-lasting, and is more thermally resistant than either wood or metal. The advanced system can be installed the same way as traditional wood jambs with no added hassles. When a fiberglass door is used together with a PF Frame, they create an enhanced, impenetrable entryway.



Primed



Fir Grain

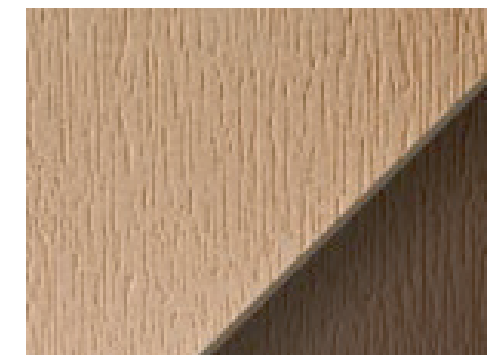

Woodgrain

WHY ASK FOR FRAMESAVER?

FrameSaver Door Frames from Endura are simply the best door frames on the market. They are so dependable they come with a lifetime transferable warranty that nobody can match. Our patented composite bottom won't absorb water, warp, crack, or rot, and finishes and paints just like wood. FrameSaver's finger-jointed wood composite protects the base of the frame from wicking into the wood. Rot never has a chance to begin. That's performance standard.



Inswing Door Systems

Description	Size	Actual Unit Size	Rough Opening	Outside Brickmold
Single Door Unit	2'0"	25 1/2" x 82"	26 1/4" x 82 1/2"	28" x 83 1/4"
	2'4"	29 1/2" x 82"	30 1/4" x 82 1/2"	32" x 83 1/4"
	2'6"	31 1/2" x 82"	32 1/4" x 82 1/2"	34" x 83 1/4"
	2'8"	33 1/2" x 82"	34 1/4" x 82 1/2"	36" x 83 1/4"
	2'10"	35 1/2" x 82"	36 1/4" x 82 1/2"	38" x 83 1/4"
	3'0"	37 1/2" x 82"	38 1/4" x 82 1/2"	40" x 83 1/4"
Double Door Unit	4'0"	49 7/8" x 82"	50 5/8" x 82 1/2"	52 3/8" x 83 1/4"
	4'8"	57 7/8" x 82"	58 5/8" x 82 1/2"	60 3/8" x 83 1/4"
	5'0"	61 7/8" x 82"	62 5/8" x 82 1/2"	64 3/8" x 83 1/4"
	5'4"	65 7/8" x 82"	66 5/8" x 82 1/2"	68 3/8" x 83 1/4"
	5'8"	69 7/8" x 82"	70 5/8" x 82 1/2"	72 3/8" x 83 1/4"
	6'0"	73 7/8" x 82"	74 5/8" x 82 1/2"	76 3/8" x 83 1/4"
Patio Door Unit	5'0"	62 7/8" x 82"	63 5/8" x 82 1/2"	65 3/8" x 83 1/4"
	5'4"	66 7/8" x 82"	67 5/8" x 82 1/2"	69 3/8" x 83 1/4"
	5'8"	70 7/8" x 82"	71 5/8" x 82 1/2"	73 3/8" x 83 1/4"
	6'0"	74 7/8" x 82"	75 5/8" x 82 1/2"	77 3/8" x 83 1/4"

Outswing Door Systems

Description	Size	Actual Unit Size	Rough Opening	Outside Brickmold
Single Door Unit	2'0"	25 1/2" x 81 1/4"	26 1/4" x 81 3/4"	28 1/2" x 83 3/4"
	2'4"	29 1/2" x 81 1/4"	30 1/4" x 81 3/4"	32 1/2" x 83 3/4"
	2'6"	31 1/2" x 81 1/4"	32 1/4" x 81 3/4"	34 1/2" x 83 3/4"
	2'8"	33 1/2" x 81 1/4"	34 1/4" x 81 3/4"	36 1/2" x 83 3/4"
	2'10"	35 1/2" x 81 1/4"	36 1/4" x 81 3/4"	38 1/2" x 83 3/4"
	3'0"	37 1/2" x 81 1/4"	38 1/4" x 81 3/4"	40 1/2" x 83 3/4"
Double Door Unit	4'0"	49 7/8" x 81 1/4"	50 5/8" x 81 3/4"	52 7/8" x 83 3/4"
	4'8"	57 7/8" x 81 1/4"	58 5/8" x 81 3/4"	60 7/8" x 83 3/4"
	5'0"	61 7/8" x 81 1/4"	62 5/8" x 81 3/4"	64 7/8" x 83 3/4"
	5'4"	65 7/8" x 81 1/4"	66 5/8" x 81 3/4"	68 7/8" x 83 3/4"
	5'8"	69 7/8" x 81 1/4"	70 5/8" x 81 3/4"	72 7/8" x 83 3/4"
	6'0"	73 7/8" x 81 1/4"	74 5/8" x 81 3/4"	76 7/8" x 83 3/4"
Patio Door Unit	5'0"	62 7/8" x 81 1/4"	63 5/8" x 81 3/4"	65 7/8" x 83 3/4"
	5'4"	66 7/8" x 81 1/4"	67 5/8" x 81 3/4"	69 7/8" x 83 3/4"
	5'8"	70 7/8" x 81 1/4"	71 5/8" x 81 3/4"	73 7/8" x 83 3/4"
	6'0"	74 7/8" x 81 1/4"	75 5/8" x 81 3/4"	77 7/8" x 83 3/4"

Door & Sidelites With Continuous Sill System- Inswing With Back to Back Mulls

Description	Size	Actual Unit Size	Rough Opening	Outside Brickmold
W/(1) 10" Sidelite	3'0"	49" x 82"	49 3/4" x 82 1/2"	51 1/2" x 83 1/4"
W/(1) 12" Sidelite	3'0"	51" x 82"	51 3/4" x 82 1/2"	53 1/2" x 83 1/4"
W/(1) 14" Sidelite	3'0"	53" x 82"	53 3/4" x 82 1/2"	55 1/2" x 83 1/4"
W/(2) 10" Sidelite	3'0"	60 1/2" x 82"	61 1/4" x 82 1/2"	63" x 83 1/4"
W/(2) 12" Sidelite	3'0"	64 1/2" x 82"	65 1/4" x 82 1/2"	67" x 83 1/4"
W/(2) 14" Sidelite	3'0"	68 1/2" x 82"	69 1/4" x 82 1/2"	71" x 83 1/4"

Door & Sidelites With Continuous Sill System- Outswing With Back to Back Mulls

Description	Size	Actual Unit Size	Rough Opening	Outside Brickmold
W/(1) 10" Sidelite	3'0"	49" x 81 1/4"	49 3/4" x 81 3/4"	52" x 82 3/4"
W/(1) 12" Sidelite	3'0"	51" x 81 1/4"	51 3/4" x 81 3/4"	54" x 82 3/4"
W/(1) 14" Sidelite	3'0"	53" x 81 1/4"	53 3/4" x 81 3/4"	56" x 82 3/4"
W/(2) 10" Sidelite	3'0"	60 1/2" x 81 1/4"	61 1/4" x 81 3/4"	63 1/2" x 82 3/4"
W/(2) 12" Sidelite	3'0"	64 1/2" x 81 1/4"	65 1/4" x 81 3/4"	67 1/2" x 82 3/4"
W/(2) 14" Sidelite	3'0"	68 1/2" x 81 1/4"	69 1/4" x 81 3/4"	71 1/2" x 82 3/4"

* Handicap Sill: Deduct 1" from height

* Narrow Mull Post: Deduct 1/2" per mull



HARRIS

Door and Millwork

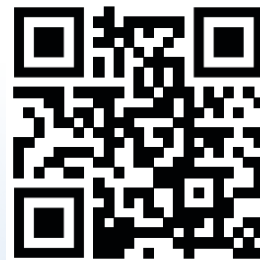

CHECK OUT
OUR WEBSITE



Contact Us

5786 HWY 129 N SUITE A
PENDERGRASS, GA 30567
PHONE: (706) 693-0060
FAX: (706) 693-0874

Follow Us

Facebook: Harris Door & Millwork
Instagram: @harrisdoorandmillwork
LinkedIn: www.linkedin.com/company/harrisdm/