





*Shown Above: Modern DD11L*

## EXTERIOR DOORS

Dyke Industries Inc. provides a wide selection of exterior doors to meet different styles and preferences. Choose from beautiful designs in our Mahogany, Shaker, Rustic, Oak, Smooth, and Modern collections. To enhance the look of these doors you can add a matching sidelite for a cohesive appearance or, choose to add decorative or privacy doorglass.

This variety ensures that every homeowner can find the perfect door to match their home's style. With quality craftsmanship and diverse designs, Dyke Industries makes it easy to find an exterior door that fits your aesthetic.



*Fiberglass 3/4 lite in Valis Red with Neo glass*



*Rustic Full Plank with large clavos*



*Fiberglass 3/4 lite in Geneva Blue with clear glass*

*Front Cover Image: Fiberglass 3/4 lite double doors in Coal Black with Chinchilla glass*

*Back Cover Image: Fiberglass 3/4 lite in Snow Mist with Berkley glass*

# INDEX

<b>About Dyke Industries</b> .....	<b>4-5</b>	<b>Additional Doorglass</b> .....	<b>72-73</b>
<b>DykeEdge</b> .....	<b>6-7</b>	<b>Clear Glass</b> .....	<b>74-75</b>
<b>Customize Your Look</b> .....	<b>8-9</b>	<b>Direct-Set Sidelite</b> .....	<b>76-77</b>
<b>HydroShield</b> .....	<b>10-11</b>	<b>Blinds</b> .....	<b>78-83</b>
<b>Fiberglass</b> .....	<b>12-31</b>	Raise Lower Tilt.....	79-81
Mahogany.....	12-13	Raise Lower Tilt with GBG.....	82-83
Shaker.....	14-17	<b>Grilles Between Glass</b> .....	<b>84-85</b>
Rustic.....	18-21	<b>External Grilles</b> .....	<b>86-87</b>
Oak.....	22-25	<b>Patio Doors</b> .....	<b>88-89</b>
Smooth.....	26-29	<b>Accessories</b> .....	<b>90-101</b>
Modern.....	30-31	Push Button Operation.....	90-91
<b>Steel</b> .....	<b>32-39</b>	iXo Frame.....	92-93
Wood Edge.....	32-35	Composite Frames and Components.....	94-95
Steel Edge.....	36-39	Doorglass Frames.....	96
<b>Versatility</b> .....	<b>40-41</b>	PanoLock.....	98-99
<b>Craftsman SDL</b> .....	<b>42-43</b>	Hardware and Componets.....	100-101
<b>Smooth Fiberglass with SDL</b> .....	<b>44-45</b>	<b>Installation, Warranty</b> .....	<b>102-111</b>
<b>Flush Glazed</b> .....	<b>46-47</b>	Specifications.....	102-103
<b>Decorative Glass</b> .....	<b>48-61</b>	Installation.....	104-107
Berkley.....	50	Warranty.....	108-111
<b>D</b> Designer Collection.....	51	<b>Steel 90-Minute</b> .....	<b>112</b>
Empire.....	52	<b>Adjustable Split Steel Frames</b> .....	<b>113</b>
Grace.....	53	<b>Commercial Doors</b> .....	<b>114-121</b>
Laurel.....	54	<b>Environment and Dyke Inc.</b> .....	<b>122-123</b>
Monterey.....	55		
Neo.....	56		
Nouveau.....	57		
Pembroke.....	58		
Prestige.....	59		
Vintage Craftsman.....	60		
Wyngate.....	61		
<b>Privacy Glass</b> .....	<b>62-71</b>		
Blanca.....	64		
Chinchilla.....	65		
Cumulus.....	66		
Micro-Granite.....	67		
Rain.....	68		
Streamed.....	69		
Vapor.....	70		
Ventlite.....	71		



Images represented throughout are digital renderings of the actual product. Colors are as close as possible to actual finish but should not be considered an exact match.

# ABOUT



Dyke Industries is a family owned company which has been in business since 1866. Dyke Industries, Inc. is the corporate successor to two millwork manufacturing companies, Dyke Bros., which was established in Fort Smith, Arkansas in 1870, and Cole Manufacturing Company, which was established in Memphis, Tennessee in 1866. The Company, in its present form was incorporated in 1942.

At the present time, the Company operates 14 distribution outlets, serving 18+ states with a broad line of building materials, including millwork, lumber, doors, windows and related items.

We serve the Southeast US as a wholesale distributor of a multitude of millwork and related products. Dyke has always been a forerunner in the millwork industry because of the belief in service. Dyke strives to deliver a quality product at a reasonable price in a timely manner.

Dyke Industries has recognized the importance of providing "Green" building products for our customers. We also recognize the importance in the practice of "Green" where it relates to operations. Dyke Industries has taken steps to recycle much of our waste in different manners to eliminate overfilling landfills.

## Our mission statement is clear:

To be the leader in the markets we service by delivering a quality product at a competitive price, on time and complete.

## Building Industry Solutions

With 14 locations throughout the Midwest, Mid-Atlantic, and Southeast; Service, Quality, and Stability is our focus.

Each facility is capable of providing our products quickly with the quality you expect. We provide hardware, doors, windows, trim and more.

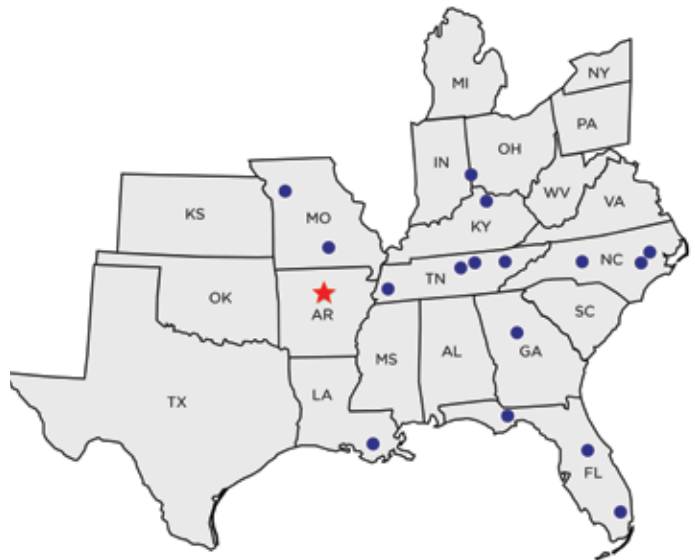



## Dyke Cincinnati Footprint

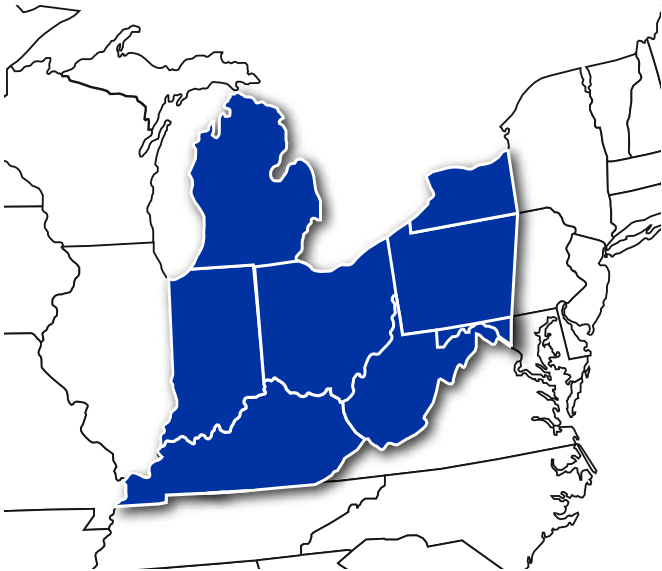

Our newest facility in Cincinnati, Ohio proudly provides services to seven states including Indiana, Kentucky, Michigan, Ohio, S.W. New York, W. Pennsylvania, and West Virginia.

### The Cincinnati Facility:

- 157,000 square feet dedicated to door production
- 4 door lines producing interior and exterior doors
- 9 semi trailers
- 4 box trucks
- 2-3 days per week delivery available
- Jobsite delivery available
- Extensive door inventory
- Full-service fire rated door shop
- Local sales teams
- Customer Service 8:00 a.m. to 4:00 p.m.





## Discover more with inspiration and planning tools to make the door fit your style!

- Build doors 24 hours a day, 7 days a week
- Instant access with personalized login
- Logic based step-by-step options to minimize mistakes
- Order history, tracking and account notifications
- View and print high-resolution images of all configured door units

To get started visit:  
[cincinnati.dykedoors.com](http://cincinnati.dykedoors.com)



Scan to visit website then click on the DykeEDGE logo in the top right corner

Talk to a live customer service representative at 859-341-5500 to be listed as an Authorized Dyke Doors Dealer.

# Step-By-Step Ordering

- 1 Visit [dykedoors.com](http://dykedoors.com) and select your location  
Selecting the location will take you to a new web-page specific to that branch



- 2 Select the DykeEDGE logo

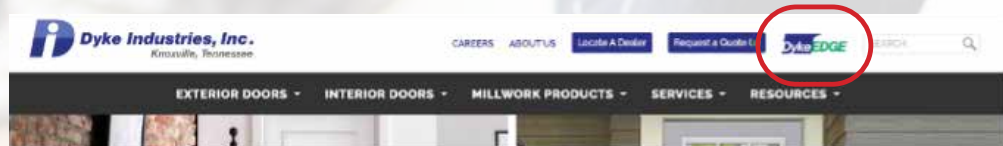

- 3 Enter your Username and Password

A screenshot of the DykeEDGE login form. The form has a title 'DykeEDGE' and a close button. It contains two input fields: 'Account Number OR Username (only use one)' and 'Password'. Below the fields is a 'Log In' button and a 'Forgot Password' link. There is also a note for administrators and a link for non-dealers.

- 4 Quote and Order from the Dashboard



# CUSTOMIZE YOUR DOOR

## ① CONFIGURATION

Customize a door configuration that best suits the opening of your home.



## ② HANDINGS

### Inswing Units



### Patio 2 Door

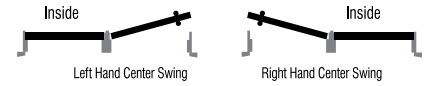

### Outswing Units

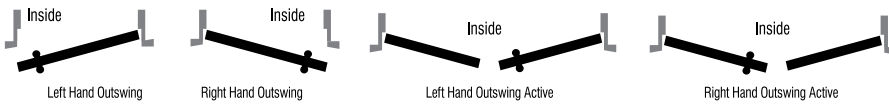

### Patio 3 Door

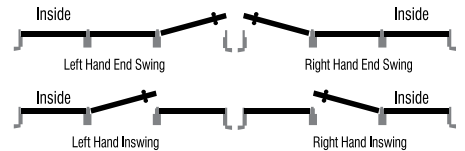

## ③ DESIGN

Browse our wide selection of door designs that compliment your home.

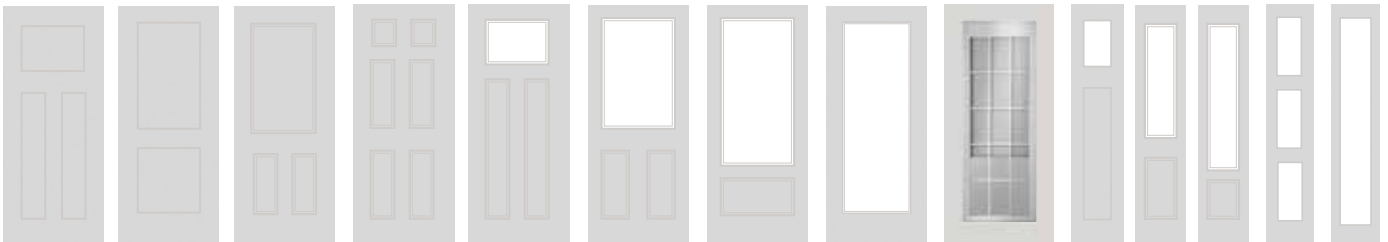

## ④ DOORGLASS

Enhancing your door with our unique glass styles can truly transform its appearance. Each design offers a special touch that reflects your personal taste and adds character to your home.



## ⑤ PAINT FINISHING

These colors not only enhance the appearance of your door but also protect it from the elements. This combination of beauty and durability makes Dyke Finish Defense a smart choice for homeowners.



All colors are shown are representative and may not be an exact match. Pre-finishing applied to fiberglass doors only. Ask your sales representative about pre-finishing your door with Finish Defense.

## ⑥ FRAMES

The important piece to seamlessly blend the door design and function.



## ⑦ HARDWARE & COMPONENTS

An extra touch and an important piece to decorate your home.

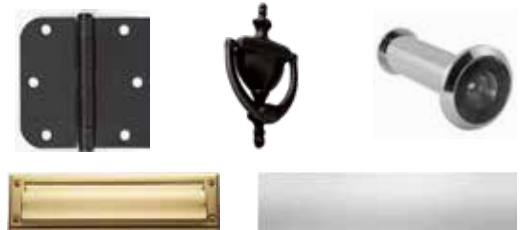

## ⑧ PLACE YOUR ORDER!

Contact your sales representative or order online with DykeEDGE.

**Dyke**EDGE



## HydroShield<sup>®</sup> technology

Our exclusive HydroShield Technology protects our doors against moisture and humidity infiltration by creating a fully composite barrier that encases and protects the door on all six sides. It prevents warping, delamination, corrosion, rotting, and the buildup of mold and mildew. When paired with our composite frames, our doors with HydroShield Technology create an impenetrable entryway.

### OUR DOORS

- 1 FULL LENGTH COMPOSITE STILES & RAILS**  
 Our full-length composite stiles and rails are water resistant and protect the door from external moisture infiltration.
- 2 HIGH DENSITY POLYURETHANE FOAM CORE**  
 Our high-density PU foam adheres tightly to the door skin, providing rigid structure and leaving no room for condensation to build up inside the door. It also enhances the door's soundproofing capabilities and provides 6 times more insulation than wood doors.
- 3 FULL-LENGTH LOCK BLOCK**  
 Plastpro's full length lock block allows any type of lock and hardware to be placed for enhanced security and increases the door's structure and rigidity.
- 4 COMPOSITE FRAME**  
 Composite frames are water resistant, have a longer life span, have twice the screw holding power, and are 25% more rigid than wood.

### THEIR DOORS

- 1 WOOD EXPOSED STILES & LOWER QUALITY COMPOSITE RAILS**  
 Exposed wood edges allow moisture to easily penetrate the door. Lower quality composite top and bottom rails provide a lower life span.
- 2 LOWER DENSITY PU FOAM OR STYRENE FOAM CORE**  
 Lower-density PU foam and styrene foam does not adhere tightly to the door skins, creating air gaps inside the door. This leaves room for mold and mildew to grow internally and provides lower insulation and less soundproofing capability.
- 3 LOCK BLOCK**  
 An average 12" wood lock block provides less support to the door structure and limits lock and hardware options, overall providing less security to the residence.
- 4 WOOD FRAME**  
 Wood door frames will crack or rot over time. Wood is not a continuous piece, providing less structure for the door unit.



# WATER RESISTANT ENTRYWAY

Superior to the competition's, our doors are engineered with high quality composite material on all six sides. They have a longer life span, are low-maintenance, are water resistant, and provide greater support and security. When used with our composite frames, Dyke doors create an enhanced, impenetrable entryway.

## COMPOSITE FRAMES

To have the best quality entryway, it is important to consider the material of the door frame. Wood door frames are prone to warping, rotting, and cracking, while steel frames can rust and dent. You don't want to install a door or a frame that will fail.

Composite are a uniquely formulated and innovative alternative to traditional door frames. The material is durable, requires less maintenance, and has a longer lifespan. Our advanced frame can be installed the same way as traditional wood frames with no added hassle.



## FRAME DECAY COMPARISON



### Traditional Wood Frame

Wood will rot and warp overtime leading to a weakened frame and weather and insect infiltration



### Composite Frame

Designed to hold up long-term against unwanted outdoor infiltration with a closed cellular structure and poly-fiber cover.

## FEATURES & BENEFITS

- ✓ Equipped with HydroShield Technology, it will not absorb or wick moisture, and prevents warping, rotting, and splitting.
- ✓ Frame cannot be infested with termites at any point along the structure.
- ✓ Has twice the screw holding power of traditional wood door frames.
- ✓ More versatility in design. Available in various lengths and widths that can be stained as well as painted.
- ✓ Continuous piece with no finger joint and is 25 percent more rigid than wood frames.
- ✓ Maintenance free and energy efficient.



# FIBERGLASS MAHOGANY



*Fiberglass Mahogany 1/2 lite with Blanca glass*



## Classic Crafting

This series features an assortment of panel designs that will endure and lend a classic, traditional aesthetic to any home.



## Elegant Design

Our Mahogany Doors evoke the timeless elegance of a wood cherished worldwide.



## Various Styles

The Mahogany Door line can accommodate a variety of glass options that perfectly complement the classic design of these doors.



M48DX

Door	3'0"
6'8"	●



M6P

Door	3'0"
6'8"	●
8'0"	●

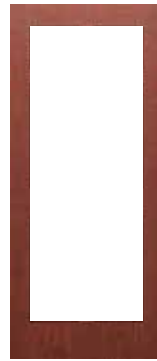

MC64

Door	3'0"
6'8"	●
8'0"	●



MC362P

Door	3'0"
6'8"	●
8'0"	●



MC48DX

Door	3'0"
6'8"	●
8'0"	●



MC64

Sidelite	1'0"
6'8"	●
7'0"	●
8'0"	●



MC362P

Sidelite	1'0"
6'8"	●
8'0"	●

Contact your sales representative for Flush Glazed options.

● Available

*Broken pallet charges may apply on special orders.*



Fiberglass Mahogany 6 panel

# SHAKER FIR AND SMOOTH



*Craftsman Shaker 1 lite, 5 lite transom, and sidelites in Pure White with Clear glass*



## **Simplicity**

The increasingly popular Craftsman Shaker Styles includes clean profiles that fit modern trends.



## **Trending Selection**

This series seamlessly complements a variety of design aesthetics, from traditional to contemporary.



## **Suitable Looks**

Create a cohesive, enduring look throughout your home's interior and exterior.



Shaker Craftman SHF1P

Door	2'8"	2'10"	3'0"
6'8"	•	•	•



Shaker Craftman SHF2P

Door	2'8"	2'10"	3'0"
6'8"	•	•	•



Shaker Craftman SHFC3

Door	2'8"	2'10"	3'0"	3'6"
6'8"	•	•	•	
8'0"			•	•



Shaker Craftman SHF3P

Door	2'8"	2'10"	3'0"
6'8"	•	•	•



Shaker Craftman SHF5P

Door	2'8"	2'10"	3'0"
6'8"	•	•	•



Shaker Craftman SHS1P

Door	2'8"	2'10"	3'0"
6'8"	•	•	•
8'0"	•	•	•



Shaker Craftman SHS2P

Door	2'8"	2'10"	3'0"
6'8"	•	•	•



Shaker Craftman SHSC3

Door	2'8"	2'10"	3'0"
6'8"	•	•	•
8'0"			•

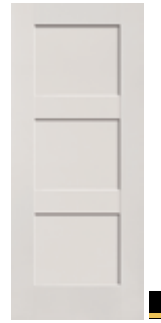

Shaker Craftman SHS3P

Door	2'8"	2'10"	3'0"
6'8"	•	•	•



Shaker Craftman SHS5P

Door	2'8"	2'10"	3'0"
6'8"	•	•	•



Shaker Craftman SHSD

Sidelite	1'0"
6'8"	•



Shaker Craftman SHC

Sidelite	1'0"
6'8"	•
8'0"	•



Shaker Craftman SHSC

Sidelite	1'0"
6'8"	•

• Available    ■ 10" Bottom Rail Available    🔥 20 Minute Fire Rated Available

*Broken pallet charges may apply on special orders.*

# SHAKER FLUSH GLAZED



Shaker Craftsman  
SHCF3P1L

Door	3'0"
6'8"	●
8'0"	●

Direct Glazed



Shaker Craftsman  
SHCF3P3L

Door	3'0"
6'8"	●
8'0"	●

Direct Glazed



Shaker Craftsman  
SHCF3P6L

Door	3'0"
6'8"	●
8'0"	●

Direct Glazed



Shaker Craftsman  
SHFC64

Door	1'2"
6'8"	●
8'0"	●



Shaker Craftsman  
SHFCC

Door	1'2"
6'8"	●
8'0"	●



Shaker Craftsman  
SHFCC2L

Door	1'2"
6'8"	●
8'0"	●

Contact your sales representative for Flush Glazed options.

● Available

*Broken pallet charges may apply on special orders.*

# SHAKER SMOOTH



Shaker Craftsman  
SHC3P1L

Door	3'0"
6'8"	●
8'0"	●

Direct Glazed



Shaker Craftsman  
SHC3P3L

Door	3'0"
6'8"	●
8'0"	●

Direct Glazed



Shaker Craftsman  
SHC3P6L

Door	3'0"
6'8"	●
8'0"	●

Direct Glazed



Shaker Craftsman  
SHC64

Sidelite	1'0"	1'2"
6'8"	●	●
8'0"	●	●



Shaker Craftsman  
SHCC

Door	1'2"
6'8"	●
8'0"	●



Shaker Craftsman  
SHCC2L

Door	1'2"
6'8"	●
8'0"	●

Contact your sales representative for Flush Glazed options.

● Available

*Broken pallet charges may apply on special orders.*

# FIBERGLASS RUSTIC

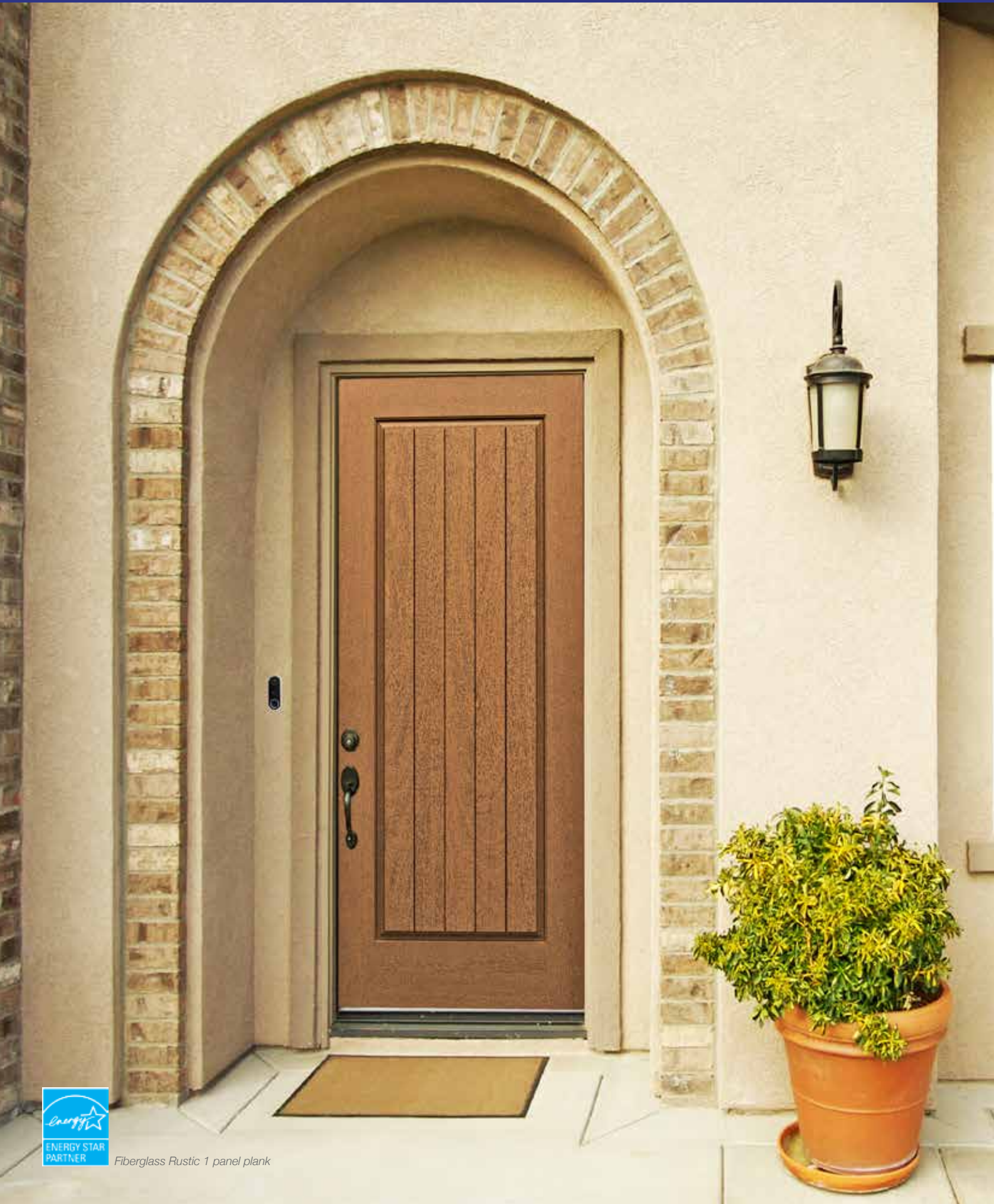

Fiberglass Rustic 1 panel plank



### **Rustic Grain**

Rustic Grain Doors feature simple fir graining and exudes simplicity, perfect for modern trends.



### **Authentic Accessories**

Decorative hardware and hinge straps will lend character to our Rustic Door collection that enhance the vintage aesthetic of our products.



### **Stain Compatible**

Stain your Rustic Grain door to achieve a custom look, and maximize visual impact.

# FIBERGLASS RUSTIC



RFP

Door	2'8"	3'0"	3'6"
6'8"	●	●	●
7'0"		●	●
8'0"	●	●	●



R1PP

Door	3'0"	3'6"
6'8"	●	
8'0"	●	●



R1PAT

Door	3'0"	3'6"
8'0"	●	●



R36

Door	3'0"
6'8"	●



R36P

Door	3'0"	3'6"
8'0"	●	●



R36PAT

Door	3'0"	3'6"
6'8"	●	●
8'0"	●	●



R36AT

Door	3'0"	3'6"
6'8"	●	●
8'0"	●	●



R4RT

Door	3'0"	3'6"
8'0"	●	●



RC1P

Door	3'0"	3'6"
6'8"	●	●
8'0"	●	●



RC36

Door	3'0"	3'6"
6'8"	●	●



RC36P

Door	3'0"	3'6"
6'8"	●	
8'0"	●	●



RC36AT

Door	3'0"
6'8"	●
8'0"	●



RC36ATP

Door	3'0"	3'6"
6'8"	●	
8'0"	●	●

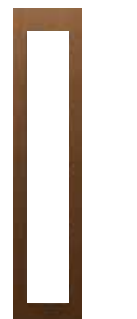

RCS64

Sidelite	1'0"
6'8"	●

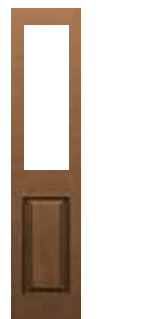

RCS36

Sidelite	1'0"
6'8"	●

Contact your sales representative for Flush Glazed options.

● Available    🔥 20 Minute Fire Rated Available

*Broken pallet charges may apply on special orders.*



*Fiberglass Rustic 2 Panel arched top*

# FIBERGLASS OAK



*Fiberglass Oak 6 panel*



### **Oak Grain Skin**

Oak is the wood of choice for traditional detail, with intricate patterns produced by its coarse texture and prominent graining.



### **Decorative Glass**

We carry a wide variety of decorative glass options that compliment the Oak Skin Door Series.



### **Stain Compatible**

Match our oak graining with a stain that fits your individual preferences, and customize your own fiberglass Oak Door.

# FIBERGLASS OAK



OF

Door	2'0"	2'4"	2'6"	2'8"	2'10"	3'0"	3'6"
6'8"	●	●	●	●	●	●	●
7'0"	●	●	●	●	●	●	●
8'0"	●	●	●	●	●	●	●



O48

Door	3'0"
6'8"	●



O482P

Door	3'0"
6'8"	●



O4P

Door	2'8"	3'0"	3'6"
6'8"	●	●	●
7'0"	●	●	●
8'0"	●	●	●



O6P

Door	2'6"	2'8"	2'10"	3'0"
6'8"	●	●	●	●
8'0"	●	●	●	●



OC1P

Door	2'8"	3'0"
6'8"	●	●
7'0"	●	●
8'0"	●	●



OCOV

Door	2'8"	3'0"
6'8"	●	●



OC362P

Door	2'8"	3'0"
6'8"	●	●
7'0"	●	●



OC36AT2P

Door	2'8"	3'0"
6'8"	●	●
7'0"	●	●



OC48

Door	3'0"
6'8"	●



OC482P

Door	2'8"	2'10"	3'0"
8'0"	●	●	●



OC480V

Door	3'0"
6'8"	●



OC480V2P

Door	3'0"
6'8"	●



OCAT4P

Door	2'8"	3'0"
6'8"	●	●
7'0"	●	●
8'0"	●	●



OCRT4P

Door	2'8"	3'0"
6'8"	●	●
7'0"	●	●
8'0"	●	●

Contact your sales representative for Flush Glazed options.

● Available    10" Bottom Rail Available    20 Minute Fire Rated Available

Broken pallet charges may apply on special orders.



OCTT4P

Door	2'8"	3'0"
6'8"	●	●
7'0"		●
8'0"		



OSL64

Sidelite	1'0"	1'2"
6'8"	●	●
8'0"	●	●



OSL48

Sidelite	1'0"	1'2"
6'8"	●	●
8'0"	●	●



OSL36

Sidelite	1'0"	1'2"
6'8"	●	●
8'0"	●	●

Contact your sales representative for Flush Glazed options.

● Available

*Broken pallet charges may apply on special orders.*



*Fiberglass Oak 6 panel*

# FIBERGLASS SMOOTH



Fiberglass 2 Panel Arch Top in Enzian Blue



### **Smooth Skin**

Our Smooth Door Skin Series is simple and gives a clean feel to any home.



### **Color Adventure**

When painted to your preferences, our Smooth Skin will compliment any home design.



### **Decorative Glass**

Our variety of available glass designs combined with the range of Smooth panel designs allows for the creation of a truly one of a kind door.

# FIBERGLASS SMOOTH

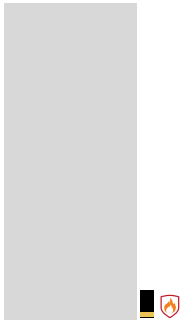

SF

Door	2'0"	2'4"	2'6"	2'8"	2'10"	3'0"	3'6"
6'8"	●	●	●	●	●	●	●
7'0"	●	●	●	●	●	●	●
8'0"	●	●	●	●	●	●	●

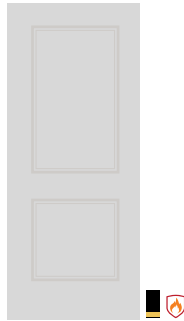

S36

Door	2'8"	2'10"	3'0"
6'8"	●	●	●
7'0"	●	●	●
8'0"	●	●	●



S362P

Door	2'8"	2'10"	3'0"
6'8"	●	●	●

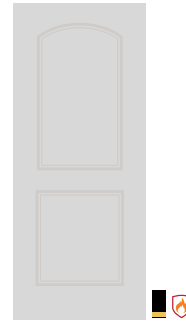

S36AT

Door	2'8"	2'10"	3'0"
6'8"	●	●	●
8'0"	●	●	●

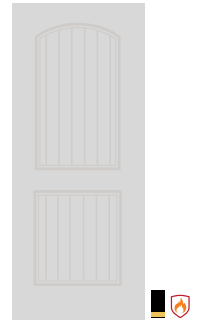

S36PAT

Door	2'8"	2'10"	3'0"
6'8"	●	●	●
8'0"	●	●	●

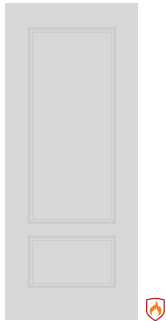

S48

Door	2'8"	2'10"	3'0"
6'8"	●	●	●
8'0"	●	●	●



S482P

Door	3'0"
6'8"	●



SC3

Door	2'8"	2'10"	3'0"
6'8"	●	●	●

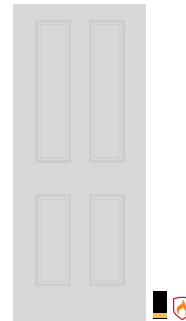

S4P

Door	2'8"	2'10"	3'0"
6'8"	●	●	●
7'0"	●	●	●
8'0"	●	●	●

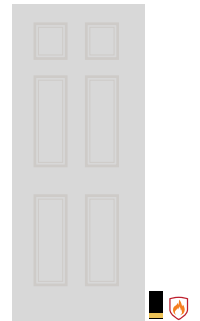

S6P

Door	2'8"	2'10"	3'0"
6'8"	●	●	●
7'0"	●	●	●
8'0"	●	●	●



SC1P

Door	2'10"	3'0"
6'8"	●	●
7'0"	●	●
8'0"	●	●

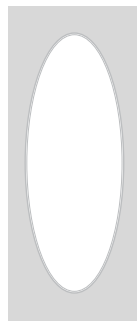

SC91964

Door	2'10"	3'0"
6'8"	●	●
7'0"	●	●
8'0"	●	●



SC36

Door	2'8"	2'10"	3'0"
6'8"	●	●	●
7'0"	●	●	●
8'0"	●	●	●



SC36AT

Door	2'8"	2'10"	3'0"
6'8"	●	●	●
7'0"	●	●	●
8'0"	●	●	●



SC36PB

Door	2'8"	2'10"	3'0"
6'8"	●	●	●
8'0"	●	●	●

Contact your sales representative for Flush Glazed options.

● Available    ■ 10" Bottom Rail Available    🔥 20 Minute Fire Rated Available

*Broken pallet charges may apply on special orders.*



SC36P

Door	2'8"	2'10"	3'0"
6'8"	●	●	●
8'0"	●	●	●



SC36AT2P

Door	2'8"	2'10"	3'0"
6'8"	●	●	●



SC36RT2P

Door	2'8"	2'10"	3'0"
6'8"	●	●	●



SC48

Door	3'0"
6'8"	●

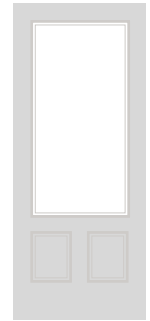

SC482P

Door	3'0"
6'8"	●



SC949

Door	3'0"
6'8"	●



SC9492P

Door	3'0"
6'8"	●



SC4PRT

Door	2'8"	2'10"	3'0"
6'8"	●	●	●



SC4PAT

Door	2'8"	2'10"	3'0"
6'8"	●	●	●



SC6P

Door	2'8"	2'10"	3'0"
6'8"	●	●	●



SSL64

Sidelite	1'0"
6'8"	●
8'0"	●



SSL48

Sidelite	1'0"
6'8"	●
8'0"	●



SSL36

Sidelite	1'0"
6'8"	●
8'0"	●



SSCC

Sidelite	1'0"	1'2"
6'8"	●	●
8'0"	●	●

Contact your sales representative for Flush Glazed options.

● Available ■ 10" Bottom Rail Available 🔥 20 Minute Fire Rated Available

Broken pallet charges may apply on special orders.

# FIBERGLASS MODERN



*Fiberglass Modern 3 lite and full lite sidelite in Valis Red with Rain glass and Coal Black composite jamb*



## Clean Design

Minimalistic Styles offer a sense of serenity in a hectic world and remains a timeless favorite.



## Unique Lite

Elevate your entryway with our custom-crafted door lites that add a one-of-a-kind touch of elegance to your home



## Groove Models

The minimal, router inscribed doors create a clean, contemporary look bringing a more modern touch to your home.

## Smooth



MDS Bienvenue - L

Door	2'8"	2'10"	3'0"	3'6"
6'8"	●	●	●	●
7'0"	●	●	●	●
8'0"	●	●	●	●



MDS Bienvenue - R

Door	2'8"	2'10"	3'0"	3'6"
6'8"	●	●	●	●
7'0"	●	●	●	●
8'0"	●	●	●	●



MDS3L

Door	2'8"	2'10"	3'0"	3'6"
6'8"	●	●	●	●
7'0"	●	●	●	●
8'0"	●	●	●	●



MDS5L

Door	2'8"	2'10"	3'0"	3'6"
6'8"	●	●	●	●
7'0"	●	●	●	●
8'0"	●	●	●	●



MDS10L

Door	2'8"	2'10"	3'0"	3'6"
6'8"	●	●	●	●
7'0"	●	●	●	●
8'0"	●	●	●	●

## Dyke Designer Collection

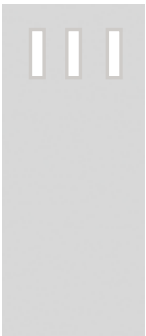

DD1

Door	2'8"	2'10"	3'0"	3'6"
6'8"	●	●	●	●
7'0"	●	●	●	●
8'0"	●	●	●	●



DD2

Door	2'8"	2'10"	3'0"	3'6"
6'8"	●	●	●	●
7'0"	●	●	●	●
8'0"	●	●	●	●



DD3

Door	2'8"	2'10"	3'0"	3'6"
6'8"	●	●	●	●
7'0"	●	●	●	●
8'0"	●	●	●	●



DD4

Door	2'8"	2'10"	3'0"	3'6"
6'8"	●	●	●	●
7'0"	●	●	●	●
8'0"	●	●	●	●



DD5

Door	2'8"	2'10"	3'0"	3'6"
6'8"	●	●	●	●
7'0"	●	●	●	●
8'0"	●	●	●	●

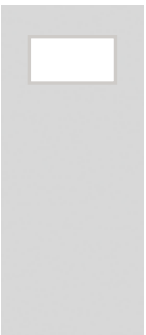

DD6

Door	2'8"	2'10"	3'0"	3'6"
6'8"	●	●	●	●
7'0"	●	●	●	●
8'0"	●	●	●	●



DD7

Door	2'8"	2'10"	3'0"	3'6"
6'8"	●	●	●	●
7'0"	●	●	●	●
8'0"	●	●	●	●



DD8

Door	2'8"	2'10"	3'0"	3'6"
6'8"	●	●	●	●
7'0"	●	●	●	●
8'0"	●	●	●	●



DD9

Door	2'8"	2'10"	3'0"	3'6"
6'8"	●	●	●	●
7'0"	●	●	●	●
8'0"	●	●	●	●

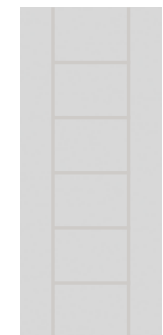

DMS5H

Door	3'0"
6'8"	●

Custom designed, custom ordered. Glass installed with lite frames.

# STEEL - WOOD EDGE



Steel Wood Edge 2 Panel in White Christmas



### **Durability**

Wood-Edge Steel Doors are constructed with top-quality, 24-gauge galvanized steel.



### **Performance & Beauty**

Get the best of both worlds with our variety of high-definition and standard panel profiles.



### **Low Maintenance**

Steel doors require minimal upkeep, allowing you to save on both time and money.

# STEEL WOOD EDGE

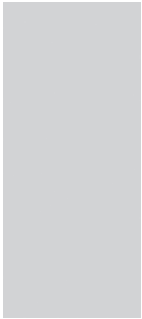

SWF

Door	2'0"	2'6"	2'8"	2'10"	3'0"	3'6"
6'8"	●	●	●	●	●	●
7'0"	●	●	●	●	●	●
8'0"	●	●	●	●	●	●



SW2PSQ

Door	2'8"	2'10"	3'0"
6'8"	●	●	●



SW2PAT

Door	2'8"	2'10"	3'0"
6'8"	●	●	●



SW48

Door	2'8"	2'10"	3'0"
6'8"	●	●	●
8'0"	●	●	●



SW6P

Door	2'6"	2'8"	2'10"	3'0"
6'8"	●	●	●	●
7'0"		●	●	●
8'0"		●	●	●

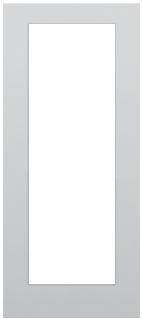

SWC1P

Door	2'6"	2'8"	2'10"	3'0"
6'8"	●	●	●	●
7'0"	●	●	●	●
8'0"	●	●	●	●



SWC36

Door	2'8"	2'10"	3'0"
6'8"	●	●	●



SWC36AT

Door	2'8"	2'10"	3'0"
6'8"	●	●	●



SWC362P

Door	2'6"	2'8"	2'10"	3'0"
6'8"		●	●	●
7'0"		●	●	●
8'0"		●	●	●



SWC36AT2P

Door	2'8"	2'10"	3'0"
6'8"	●	●	●
7'0"	●	●	●
8'0"	●	●	●



SWC36RT2P

Door	2'8"	2'10"	3'0"
6'8"	●	●	●
7'0"	●	●	●
8'0"	●	●	●



SWC48

Door	2'8"	2'10"	3'0"
6'8"	●	●	●
8'0"	●	●	●



SWCAT4P

Door	2'8"	2'10"	3'0"
6'8"	●	●	●
7'0"	●	●	●
8'0"	●	●	●



SWCRT4P

Door	2'8"	2'10"	3'0"
6'8"	●	●	●
7'0"	●	●	●
8'0"	●	●	●



SWC6P

Door	2'6"	2'8"	2'10"	3'0"
6'8"	●	●	●	●
7'0"		●	●	●
8'0"		●	●	●

Contact your sales representative for Flush Glazed options.

● Available

Broken pallet charges may apply on special orders.



SWS64

Sidelite	1'0"	1'2"	1'6"
6'8"	●	●	●



SWS48

Sidelite	1'0"	1'2"	1'6"
6'8"	●	●	●



SWS36

Sidelite	1'0"	1'2"	1'6"
6'8"	●	●	●

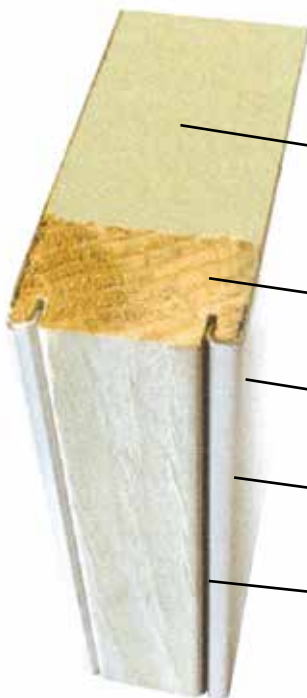

CFC Free Polyurethane foam core provides superior insulation, added strength, and reduces sound transmission

Constructed with wide 1-1/8" solid wood stiles

12" or 24" Lock Block

High quality 24-gauge galvanized steel

Durable "J" bend technology

Contact your sales representative for Flush Glazed options.

● Available

*Broken pallet charges may apply on special orders.*

# STEEL - STEEL EDGE



*Steel 3/4 Lite in Pure White with clear glass*



### **Security**

Reinforced lock areas, rot resistant bottom rails and a strong, durable finish provide solid security.



### **Energy Efficient**

The polyurethane foam core insulating properties add to the energy efficiency and limits the sound transmission into the home.



### **Fire Protection**

For house to the garage entryway fire-resistant doors offer a secure and reliable solution.

# STEEL STEEL EDGE

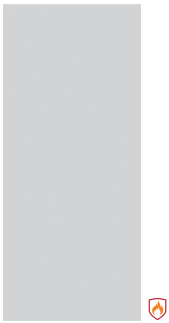

SEF

Door	2'0"	2'6"	2'8"	2'10"	3'0"	3'6"
6'8"	•	•	•	•	•	•
7'0"	•	•	•	•	•	•
8'0"	•	•	•	•	•	•



SE36

Door	2'8"	2'10"	3'0"
6'8"	•	•	•



SE36AT

Door	2'8"	2'10"	3'0"
6'8"	•	•	•



SE48

Door	2'8"	2'10"	3'0"
6'8"	•	•	•
7'0"	•	•	•



SE6P

Door	2'6"	2'8"	2'10"	3'0"	3'6"
6'8"	•	•	•	•	•
7'0"	•	•	•	•	•
8'0"	•	•	•	•	•

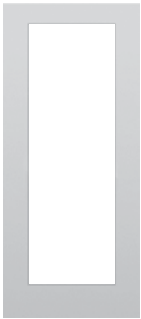

SEC1P

Door	2'6"	2'8"	2'10"	3'0"
6'8"	•	•	•	•
7'0"	•	•	•	•
8'0"	•	•	•	•



SEC36

Door	2'8"	2'10"	3'0"
6'8"	•	•	•



SEC36AT

Door	2'8"	2'10"	3'0"
6'8"	•	•	•



SEC362P

Door	2'6"	2'8"	2'10"	3'0"
6'8"	•	•	•	•
7'0"	•	•	•	•
8'0"	•	•	•	•



SEC36AT2P

Door	2'8"	2'10"	3'0"
6'8"	•	•	•
7'0"	•	•	•
8'0"	•	•	•



SEC36RT2P

Door	2'8"	2'10"	3'0"
6'8"	•	•	•
7'0"	•	•	•
8'0"	•	•	•



SEC48

Door	2'8"	2'10"	3'0"
6'8"	•	•	•
8'0"	•	•	•



SECAT4P

Door	2'8"	2'10"	3'0"
6'8"	•	•	•
7'0"	•	•	•
8'0"	•	•	•



SECR4P

Door	2'8"	2'10"	3'0"
6'8"	•	•	•
7'0"	•	•	•
8'0"	•	•	•



SEC6P

Door	2'6"	2'8"	2'10"	3'0"
6'8"	•	•	•	•
7'0"	•	•	•	•
8'0"	•	•	•	•

Contact your sales representative for Flush Glazed options.

• Available    🔥 90 Minute Fire Rated Available

*Broken pallet charges may apply on special orders.*



SES64

Sidelite	1'0"	1'2"	1'6"
6'8"	●	●	●



SES48

Sidelite	1'0"	1'2"	1'6"
6'8"	●	●	●



SES36

Sidelite	1'0"	1'2"	1'6"
6'8"	●	●	●

Contact your sales representative for Flush Glazed options.

● Available

*Broken pallet charges may apply on special orders.*



Hot Dipped Galvanized for superior corrosion resistance

4"x12" wood lock-block reinforcement on wood-edge doors (4"x24" on 6ft doors) ensure that cylindrical hardware is mounted securely.

Features high-definition panel profiles

Structural Polyurethane foam core for superior thermal performance, added strength, and reduced sound transmission, 2.2lbs cu. ft.

	Wood Edge	Steel Edge
Warranty	<ul style="list-style-type: none"> <li>10 Years</li> </ul>	<ul style="list-style-type: none"> <li>10 Years</li> </ul>
Panel Definition	<ul style="list-style-type: none"> <li>24-gauge Steel</li> <li>High-Definition Embossed Designs</li> </ul>	<ul style="list-style-type: none"> <li>24-gauge Steel</li> <li>High-Definition Embossed Designs</li> </ul>
Grain Texture	<ul style="list-style-type: none"> <li>Smooth Steel</li> </ul>	<ul style="list-style-type: none"> <li>Smooth Steel</li> </ul>
Construction	<ul style="list-style-type: none"> <li>J-bend Interlocking Skins</li> </ul>	<ul style="list-style-type: none"> <li>Interlocking Skins</li> </ul>
Material	<ul style="list-style-type: none"> <li>Hot dipped galvanized</li> </ul>	<ul style="list-style-type: none"> <li>Hot dipped galvanized</li> </ul>
Finish Selections	<ul style="list-style-type: none"> <li>Primed white surface</li> </ul>	<ul style="list-style-type: none"> <li>Primed white surface</li> </ul>
Security	<ul style="list-style-type: none"> <li>4"x12" Wood lock-block reinforcement</li> </ul>	<ul style="list-style-type: none"> <li>4"x12" Poly-lock block</li> </ul>
Durability	<ul style="list-style-type: none"> <li>Limited Lifetime Warranty</li> </ul>	<ul style="list-style-type: none"> <li>Limited Lifetime Warranty</li> </ul>
Glass Selection	<ul style="list-style-type: none"> <li>Wide range of available glass choices</li> </ul>	<ul style="list-style-type: none"> <li>Wide range of available glass choices</li> </ul>
Core	<ul style="list-style-type: none"> <li>High Performance Polyurethane 2.2lbs cu. ft.</li> </ul>	<ul style="list-style-type: none"> <li>High Performance Polyurethane 2.2lbs cu. ft.</li> </ul>
Fire-Rated	<ul style="list-style-type: none"> <li>20 minute available</li> </ul>	<ul style="list-style-type: none"> <li>90 minute available</li> </ul>
Hinge Prep	<ul style="list-style-type: none"> <li>Fixed</li> </ul>	<ul style="list-style-type: none"> <li>Adjustable</li> </ul>

# VERSATILITY

noun

1. ability to adapt or be adapted to many different functions or activities

Solid core, 1 3/4" primed doors enhance a home's character and charm, offering more than just a standard interior door.

Homeowners can seamlessly match the 20-minute fire-rated garage-to-house door with the design style of their interior doors. This coordinated look not only appears great, but also meets expectations and provides stylish options for the homeowner.



Conmore 5 Panel in Pure White



Madison

Door	2'8"	3'0"
6'8"	•	•
8'0"	•	•



Camden

Door	2'8"	3'0"
6'8"	•	•



Monroe

Door	2'8"	3'0"
6'8"	•	•
8'0"	•	•



Santa Fe

Door	2'8"	3'0"
6'8"	•	•
8'0"	•	•



Caiman

Door	2'8"	3'0"
6'8"	•	•



Carrara

Door	2'8"	3'0"
6'8"	•	•
8'0"	•	•



Craftsman 3

Door	2'8"	3'0"
6'8"	•	•



Birkdale

Door	2'8"	3'0"
6'8"	•	•
8'0"	•	•



Conmore

Door	2'8"	3'0"
6'8"	•	•



Rockport

Door	2'8"	3'0"
6'8"	•	•
8'0"	•	•



Colonist Textured

Door	2'8"	3'0"
6'8"	•	•
8'0"	•	•



Colonist Smooth

Door	2'8"	3'0"
6'8"	•	•
8'0"	•	•



• Available  20 Minute Fire Rated Available  
Stock Sizes Shown

# SIMULATED DIVIDED LITES - SDL

From modern lofts to traditional craftsman style, designers and builders have used the iconic look of divided lites to add accent to a home's residential design and history.

Add smooth or woodgrain bars to add depth and dimensions to your style.



**Flat Craftsman**  
Flat Grille



**Traditional**  
Contoured Grille



SDL's match substrate of door. Call for custom SDL patterns.



Fiberglass Rustic 3/4 panel 6 lite SDL with 3 lite SDL sidelite

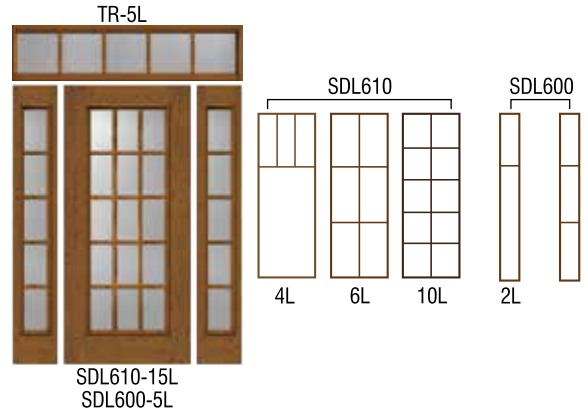
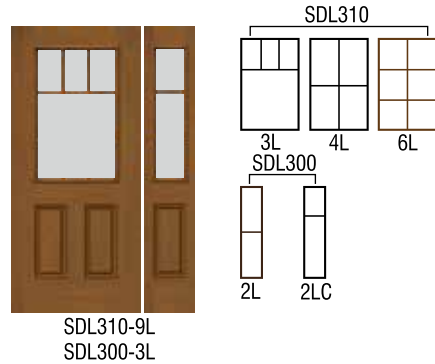
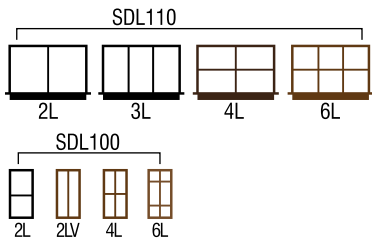

# SMOOTH FIBERGLASS SDL



*Fiberglass 6 lite SDL in Forest Green with direct set sidelites and clear glass*



## Wide SDL's

Simulated Divided Panel doors feature wider SDL's from 3-1/2" to 5" applied to the glass.



## Designed for You

With a range of configurations, shapes, and styles, you can curate a look that perfectly reflects your personal aesthetic and functional needs.



## Trending Statement

Due to the more modern look of these doors, they are becoming a popular way to elevate your doorway.

# CONTEMPORARY DESIGN SDL

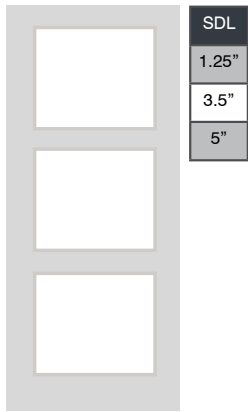

CD3

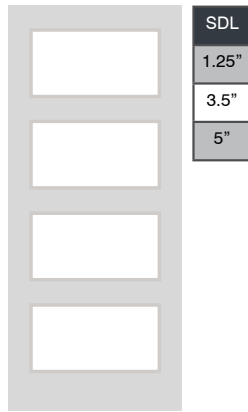

CD4

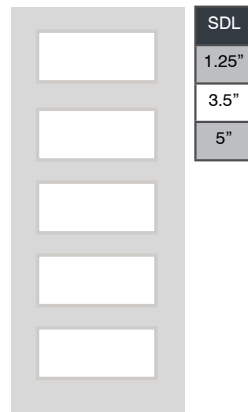

CD5

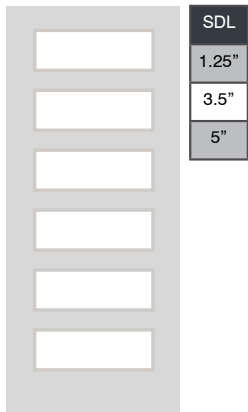
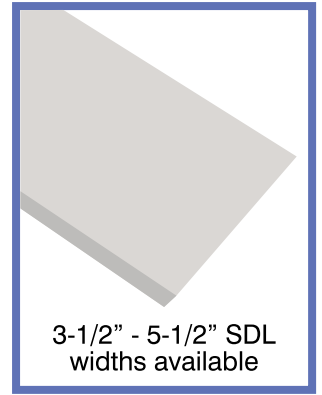

CD6

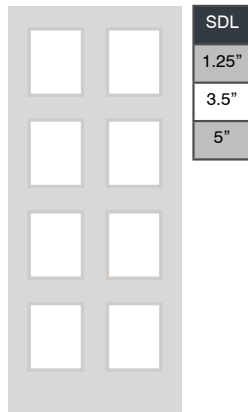

CD8

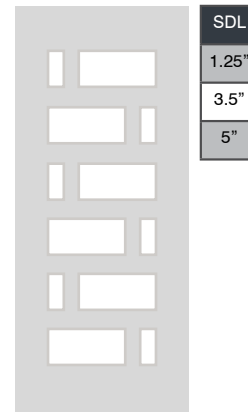

CD12

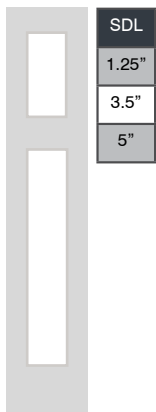

CD2SL

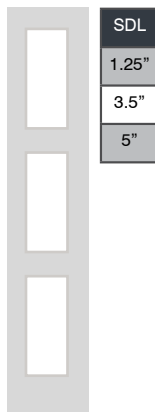

CD3SL

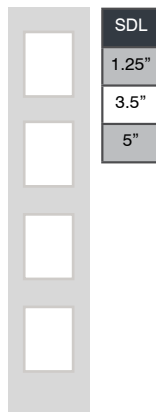

CD4SL

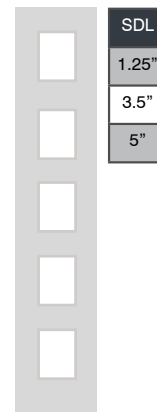

CD5SL

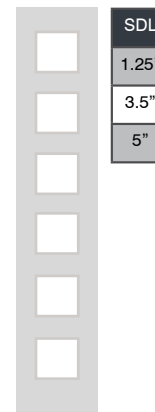

CD6SL

Flush Glazed

# FLUSH GLAZED



*Fiberglass 3/4 lite 6 lite SDL and 3 lite SDL sidelites in Enzian Blue with clear glass*



- Glass glazed directly into door
- 3/4" Insulated Glass
- Seamless blend between glass and door
- Allows maximum light into home



GZ48  
Door 3'0"  
6'8" ●

GZ48  
Door 3'0"  
8'0" ●

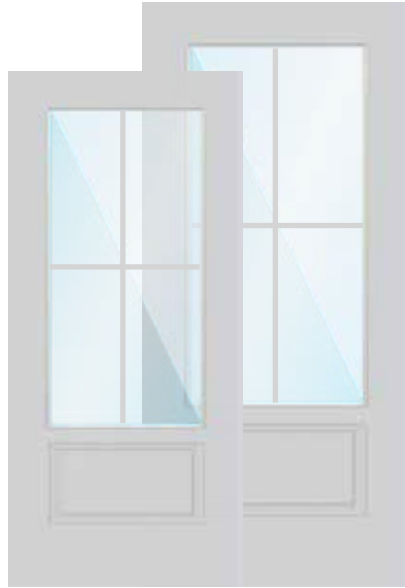

GZ484L  
Door 3'0"  
6'8" ●

GZ484L  
Door 3'0"  
8'0" ●



GZ486L  
Door 3'0"  
6'8" ●

GZ486L  
Door 3'0"  
8'0" ●



GZ64  
Door 2'8" 3'0"  
6'8" ● ●  
8'0" ● ●



GZ48S  
Sidelite 14"  
6'8" ●  
8'0" ●



GZ48S2L  
Sidelite 14"  
6'8" ●  
8'0" ●



GZ48S3L  
Sidelite 14"  
6'8" ●  
8'0" ●

● Available Smooth Fiberglass

# DECORATIVE DOORGLASS



*Fiberglass full lite and sidelites in White Christmas with Nouveau glass*



## Complement Your Home

Our decorative door lite, sidelite, and transom designs come in a range of glass textures, coming finishes, privacy levels, and Low-E energy efficiency options to fit your style.

# DECORATIVE DOORGLASS SELECTION OVERVIEW



**Berkley**  
XB



**Designer Collection**  
XDDC

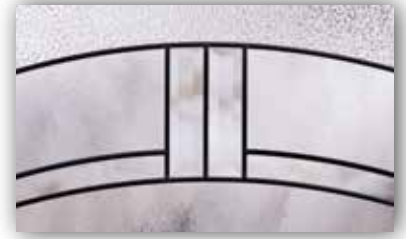

**Empire**  
XEP



**Grace**  
XG



**Laurel**  
XL



**Monterey**  
XM



**Neo**  
XNE



**Nouveau**  
XN



**Pembrook**  
XPB

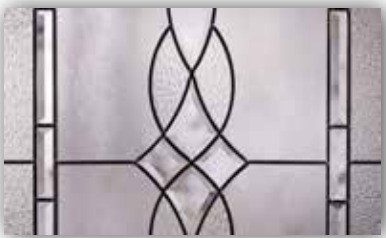

**Prestige**  
XPR



**Vintage Craftsman**  
XV



**Wyngate**  
XWY

Contact Your Sales Representative For Additional Glass Designs.

# BERKLEY



Fiberglass 3/4 lite in Nightfall with Berkley Glass

Privacy Rating: **LOW**



## CAMING



Patina

## GLASS TEXTURE



Clear Bevels



Granite



**Model** XB36  
**Size** 22"x36"  
**IG Color** Patina  
**Frame Type** Evolve  
**Frame Color** White  
**Item Number** 34019720



**Model** XB48  
**Size** 22"x48"  
**IG Color** Patina  
**Frame Type** Evolve  
**Frame Color** White  
**Item Number** 34019717



**Model** XB836  
**Size** 8"x36"  
**IG Color** Patina  
**Frame Type** Evolve  
**Frame Color** White  
**Item Number** 34019721



**Model** XB848  
**Size** 8"x48"  
**IG Color** Patina  
**Frame Type** Evolve  
**Frame Color** White  
**Item Number** 34019719

 **IN STOCK** | 
  **SPECIAL ORDER**

# DESIGNER COLLECTION



Fiberglass Modern DDC1 in White Christmas with Clear Glass

Privacy Rating:  
**Clear = 1**  
**Clear Low-E = 1**  
**Cubed = 9**  
**Frosted = 9**  
**Rain = 9**



## GLASS TEXTURE



Model | XDDC1



Model | XDDC2



Model | XDDC3



Model | XDDC4



Model | XDDC5



Model | XDDC6



Model | XDDC7



Model | XDDC8



Model | XDDC9

**IN STOCK** | 
 **SPECIAL ORDER**

# EMPIRE



Privacy Rating: **HIGH**



## CAMING

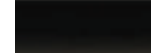

Patina

## GLASS TEXTURE



Chinchilla



Granite



Clear Bevels



Clear Glass

Fiberglass 3/4 lite and matching sidelites in Valis Red with Empire glass



Model | XEP36



Model | XEP48



Model | XEP836



Model | XEP848



**IN STOCK**



**SPECIAL ORDER**

# GRACE



Fiberglass 1/2 lite and sidelite in Enzian Blue with Grace glass

Privacy Rating: **HIGH**



## CAMING

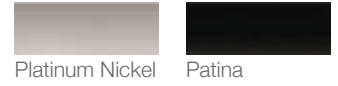

## GLASS TEXTURE



Model | XG10A



Model | XG10B



Model | XG36  
Size 22"x36"  
IG Color Patina  
Frame Type Evolve  
Frame Color Oak  
Item Number 311435



Model | XG36AT



Model | XG949



Model | XG48  
Size 22"x48"  
IG Color Patina  
Frame Type Evolve  
Frame Color Oak  
Item Number 311430



Model | XG919

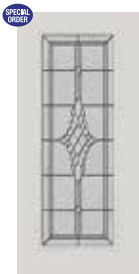

Model | XG64

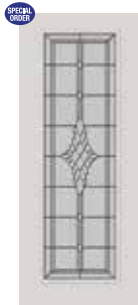

Model | XG80



Model | XG836  
Size 8"x36"  
IG Color Patina  
Frame Type Evolve  
Frame Color Oak  
Item Number 311472



Model | XG848  
Size 8"x48"  
IG Color Patina  
Frame Type Evolve  
Frame Color Oak  
Item Number 311481



Model | XG864



Model | XG880

 **IN STOCK** | 
  **SPECIAL ORDER**

# LAUREL

Privacy Rating: **HIGH**



## CAMING



## GLASS TEXTURE



Fiberglass 1/2 lite and full lite sidelites in Rustic Bronze with Laurel glass



Model | XL15



Model | XL36



Model | XL36AT



Model | XN949



Model | XN64

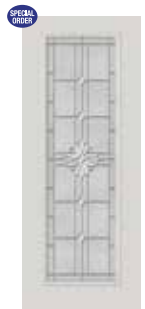

Model | XN80



Model | XL715



Model | XL836



Model | XL764



Model | XL880

 **IN STOCK** | 
  **SPECIAL ORDER**

# MONTEREY

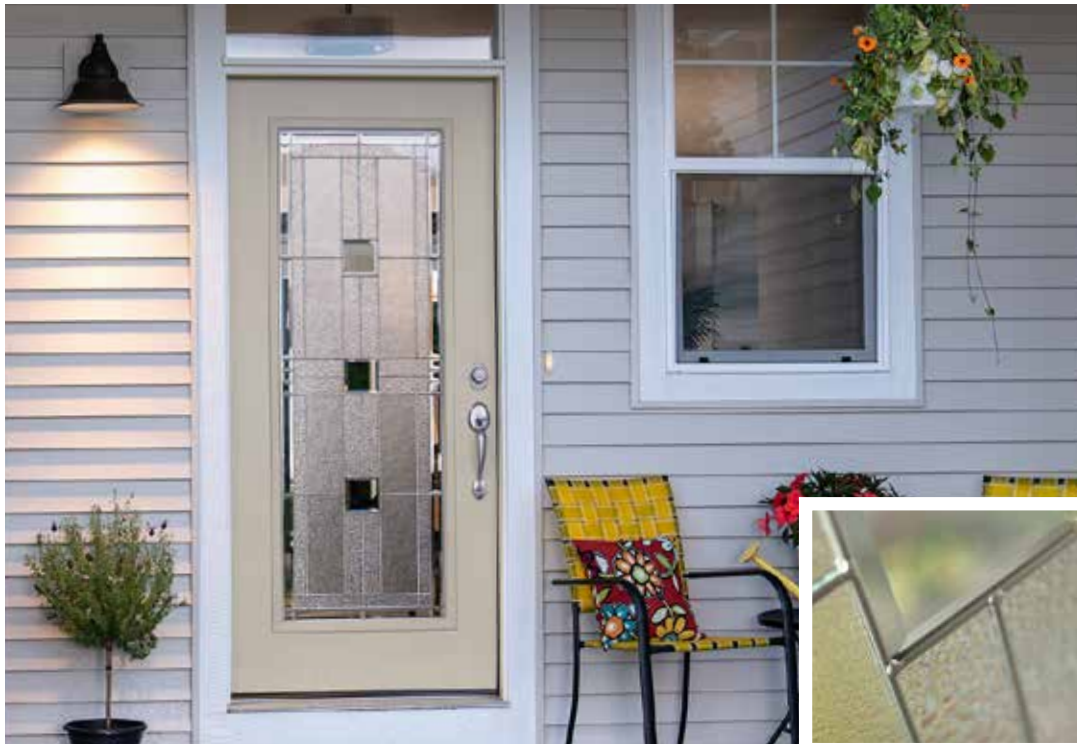

Fiberglass full lite in Sandpiper Beige with Monterey glass

Privacy Rating: **HIGH**



## CAMING



Satin Nickel

## GLASS TEXTURE



Granite



Clear Bevels



Micro-Granite



Model | XM15



Model | XM15AT



Model | XM36  
 Size 22"x36"  
 IG Color Satin Nickel  
 Frame Type Evolve  
 Frame Color White  
 Item Number 306062



Model | XM48  
 Size 22"x48"  
 IG Color Satin Nickel  
 Frame Type Evolve  
 Frame Color White  
 Item Number 309265

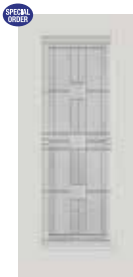

Model | XM64



Model | XM817



Model | XM848  
 Size 8"x48"  
 IG Color Satin Nickel  
 Frame Type Evolve  
 Frame Color White  
 Item Number 309269



Model | XM764



Model | XM864

IN STOCK
 

 SPECIAL ORDER

# NEO



Fiberglass 3/4 lite in Valis Red with Neo glass

Privacy Rating: **HIGH**



## CAMING



Patina

## GLASS TEXTURE



Clear Soft Wave



Micro-Cubed



Thin Reed



Model | XNE36



Model | XNE48  
 Size | 22"x48"  
 IG Color | Patina  
 Frame Type | Evolve  
 Frame Color | White  
 Item Number | 34013176



Model | XNE836



Model | XNE848  
 Size | 8"x48"  
 IG Color | Patina  
 Frame Type | Evolve  
 Frame Color | White  
 Item Number | 34013164

IN STOCK

SPECIAL ORDER
SPECIAL ORDER

# NOUVEAU



Fiberglass 3/4 panel in Coal Black with oval Nouveau glass

Privacy Rating: **LOW**



## CAMING



Platinum Nickel



Patina

## GLASS TEXTURE



Clear Soft Wave



Clear Bevels



Model | XN10A



Model | XN10B



Model | XN36R



Model | XN36



Model | XN949



Model | XN48



Model | XN919



Model | XN64



Model | XN836

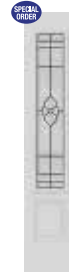

Model | XN848



Model | XN864

**IN STOCK** | 
 **SPECIAL ORDER**

# PEMBROOK



Fiberglass full lite and sidelites in Geneva Blue with Pembroke glass

Privacy Rating: **HIGH**



## CAMING



## GLASS TEXTURE



Model | XPB10B



Model | XPB15



Model | XPB36  
Size | 22"x36"  
IG Color | Patina  
Frame Type | Evolve  
Frame Color | Oak & White  
Item Number | 33006357 (O)  
33006246 (W)



Model | XPB48  
Size | 22"x48"  
IG Color | Patina  
Frame Type | Evolve  
Frame Color | Oak & White  
Item Number | 33011222 (O)  
33011133 (W)

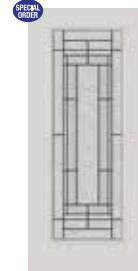

Model | XPB64

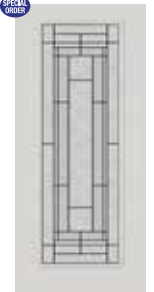

Model | XPB80

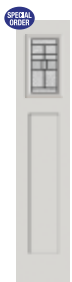

Model | XPB715



Model | XPB836  
Size | 8"x36"  
IG Color | Patina  
Frame Type | Evolve  
Frame Color | Oak & White  
Item Number | 33008727 (O)  
33008648 (W)



Model | XPB848  
Size | 8"x36"  
IG Color | Patina  
Frame Type | Evolve  
Frame Color | Oak & White  
Item Number | 33010534 (O)  
33010458 (W)



Model | XPB764



Model | XPB880

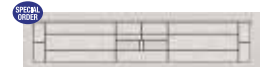

Model | XPBTRR



**IN STOCK**



**SPECIAL ORDER**

# PRESTIGE



Privacy Rating: **HIGH**



## CAMING

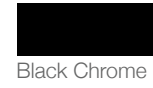

## GLASS TEXTURE



Fiberglass 3/4 lite in Clay with Prestige glass



Model | XPR36



Model | XPR48

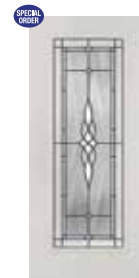

Model | XPR64



Model | XPR848



Model | XPR764



Model | XPR836

 **IN STOCK** | 
  **SPECIAL ORDER**

# VINTAGE CRAFTSMAN



Fiberglass full lite in Sterling Gray with Vintage Craftsman glass

Privacy Rating: **MEDIUM**



## CAMING



## GLASS TEXTURE



Model | XV10B



Model | XV15  
 Size | 22"x15.25"  
 IG Color | Patina  
 Frame Type | Craftsman  
 Frame Color | Oak & White  
 Item Number | 33005040 (O)  
 33004954 (W)



Model | XV36  
 Size | 22"x36"  
 IG Color | Patina  
 Frame Type | Evolve  
 Frame Color | Oak  
 Item Number | 33006335



Model | XV48  
 Size | 22"x48"  
 IG Color | Patina  
 Frame Type | Evolve  
 Frame Color | Oak  
 Item Number | 33011200

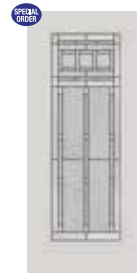

Model | XV64



Model | XV80



Model | XV715  
 Size | 7" x 15.25"  
 IG Color | Patina  
 Frame Type | Craftsman  
 Frame Color | Oak & White  
 Item Number | 33011031(O)  
 33011014(W)



Model | XV836  
 Size | 8"x36"  
 IG Color | Patina  
 Frame Type | Evolve  
 Frame Color | Oak  
 Item Number | 33008706



Model | XV848  
 Size | 8"x48"  
 IG Color | Patina  
 Frame Type | Evolve  
 Frame Color | Oak  
 Item Number | 33010513



Model | XV764

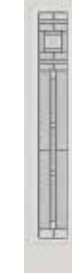

Model | XV880

**IN STOCK**

**SPECIAL ORDER**

# WYNGATE



Privacy Rating: **MAXIMUM**



CLEAR

OPAQUE

## CAMING



Black Wrought Iron

## GLASS TEXTURE



Micro-Granite

Fiberglass 3/4 lite and full lite sidelites in Chocolate Brown with Wyngate glass



Model | XWY10B



Model | XWY10A



Model | XWY15



Model | XWY36



Model | XWY48



Model | XWY64

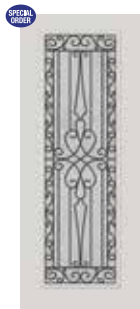

Model | XWY80

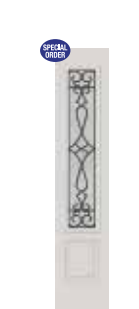

Model | XWY848

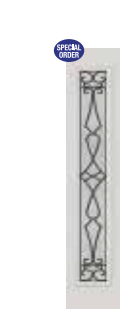

Model | XWY764

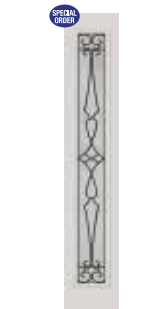

Model | XWY880

 **IN STOCK** | 
  **SPECIAL ORDER**

# PRIVACY DOORGLASS



*Fiberglass full lite in Coal Black with Rain glass*



## Light and Privacy Needs

The Privacy collection features a diverse range of textures, spanning from serene, nature-inspired designs to bold yet refined contemporary styles. The eight Opticks doorglass patterns beautifully refract and diffuse light across their textures.

Available in a wide range of door and sidelite sizes and energy efficient Low-E glass, Opticks will balance light transmission while preserving privacy.

# PRIVACY DOORGLASS SELECTION OVERVIEW

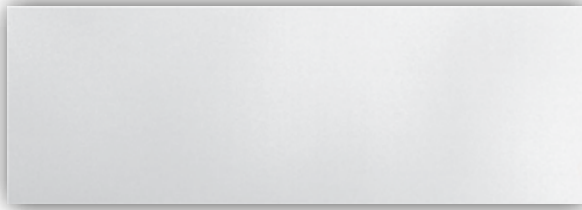

**Blanca**  
VB



**Chinchilla**  
VCH



**Cumulus**  
VC

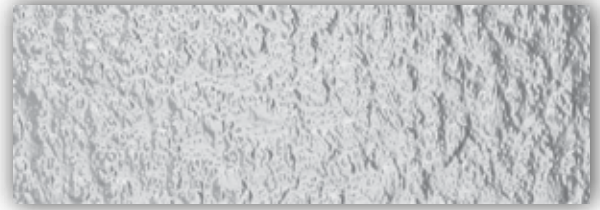

**Micro-Granite**  
VG

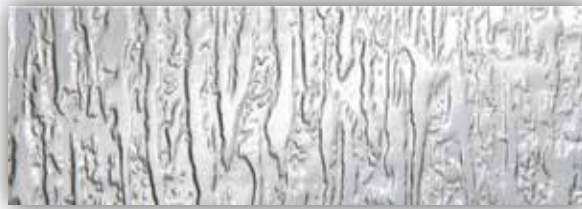

**Rain**  
VR

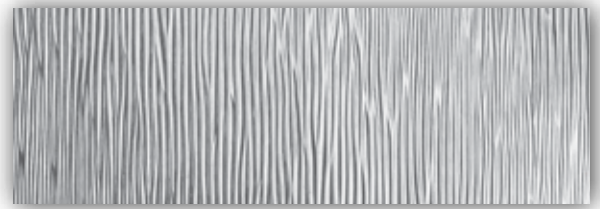

**Streamed**  
VS



**Vapor**  
VW



*Fiberglass full lite and sidelites in Forest Green with Cumulus glass*



*Fiberglass Craftsman 3 lite and full lite sidelites in Pure White with Streamed glass*

Privacy Rating: **MAXIMUM**



## TEXTURED SURFACE ENCLOSED IN GLASS

Available in:  
 Fiberglass Smooth  
 Fiberglass Fir Textured  
 Fiberglass Oak Textured  
 Primed Steel

**e** Low - E available

**SDL** Accepts Simulated Divided Lite



Model | VB10A



Model | VB15



Model | VB153L



Model | VB156L



Model | VB36  
 Size 22"x36"  
 IG Color 1" Low-E  
 Frame Type Evolve  
 Frame Color Oak & White  
 Item Number 311189 (O)  
 321090 (W)



Model | VB48  
 Size 22"x48"  
 IG Color 1" Low-E  
 Frame Type Evolve  
 Frame Color Oak & White  
 Item Number 311203 (O)  
 311204 (W)

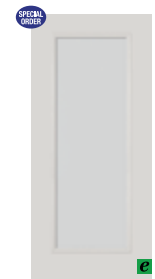

Model | VB64



Model | VB80



Model | VB715



Model | VB836  
 Size 8"x36"  
 IG Color 1" Low-E  
 Frame Type Evolve  
 Frame Color Oak & White  
 Item Number 311206 (O)  
 311205 (W)



Model | VB848  
 Size 8"x48"  
 IG Color 1" Low-E  
 Frame Type Evolve  
 Frame Color Oak & White  
 Item Number 311198 (O)  
 311199 (W)



Model | VB864

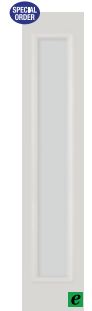

Model | VB880

**IN STOCK** | **SPECIAL ORDER**

# CHINCHILLA



Privacy Rating: **MAXIMUM**



**TEXTURED SURFACE  
EXPOSED TO THE  
INSIDE OF THE HOME**

Available in:  
 Fiberglass Smooth  
 Fiberglass Fir Textured  
 Fiberglass Oak Textured  
 Primed Steel

**e** Low - E available

**SDL** Accepts Simulated Divided Lite



Model | VCH15



Model | VCH36



Model | VCH48



Model | VCH64



Model | VCH80



Model | VCH815



Model | VCH836



Model | VCH848



Model | VCH764



Model | VCH880

✓ **IN STOCK** | 
 SPECIAL ORDER **SPECIAL ORDER**

# CUMULUS

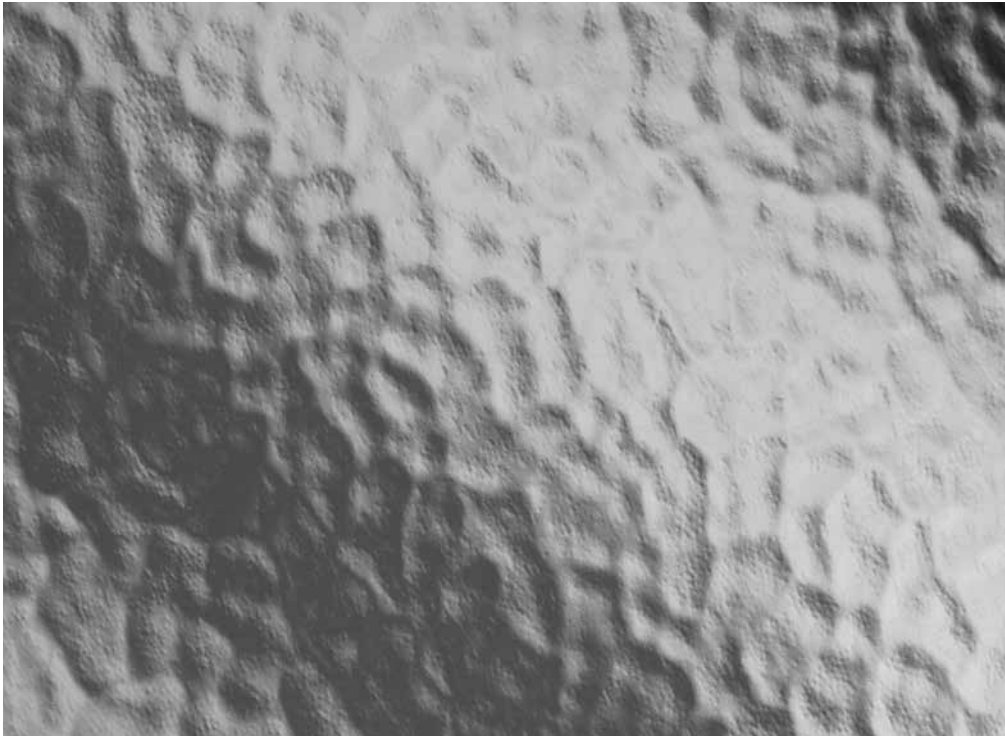

Privacy Rating: **HIGH**



**TEXTURED SURFACE  
EXPOSED TO THE  
INSIDE OF THE HOME**

Available in:  
Fiberglass Smooth  
Fiberglass Fir Textured  
Fiberglass Oak Textured  
Primed Steel

**e** Low - E available

**SDL** Accepts Simulated Divided Lite



Model | VC15



Model | VC36



Model | VC48



Model | VC64



Model | VC80



Model | VC836



Model | VC848



Model | VC764



Model | VC880

**IN-STOCK** | **SPECIAL ORDER**

# MICRO-GRANITE

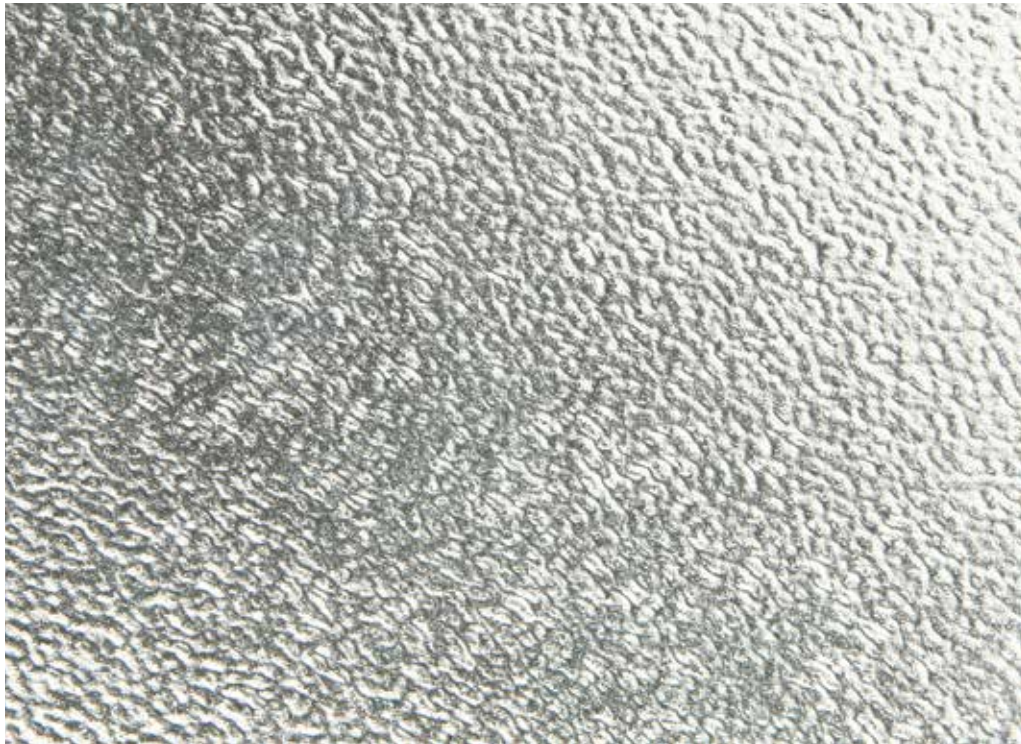

Privacy Rating: **MAXIMUM**



## TEXTURED SURFACE ENCLOSED IN GLASS

Available in:  
 Fiberglass Smooth  
 Fiberglass Fir Textured  
 Fiberglass Oak Textured  
 Primed Steel

**e** Low - E available

**SDL** Accepts Simulated Divided Lite



Model | VG15



Model | VG36  
 Size 22"x36"  
 IG Color 1" Low-E  
 Frame Type Evolve  
 Frame Color Oak & White  
 Item Number 311278 (O)  
 311280 (W)



Model | VG48



Model | VG64



Model | VG80



Model | VG715



Model | VG836  
 Size 8"x36"  
 IG Color 1" Low-E  
 Frame Type Evolve  
 Frame Color Oak & White  
 Item Number 311307 (O)  
 311309 (W)



Model | VG864



Model | VG764



Model | VG880

 **IN STOCK** | 
  **SPECIAL ORDER**

# RAIN

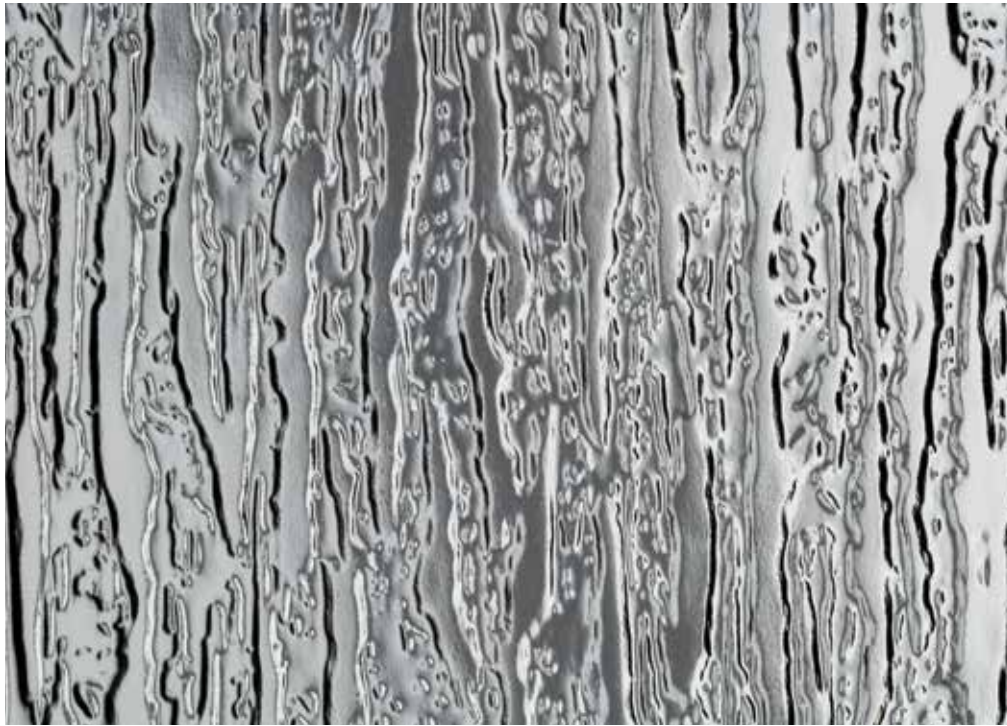









Privacy Rating: **MAXIMUM**



## TEXTURED SURFACE ENCLOSED IN GLASS

Available in:  
 Fiberglass Smooth  
 Fiberglass Fir Textured  
 Fiberglass Oak Textured  
 Primed Steel

**e** Low - E available

							
<b>Model</b>   VR15	<b>Model</b>   VR153L	<b>Model</b>   VR156L	<b>Model</b>   VR36 Size 22"x36" IG Color 1" Low-E Frame Type Evolve Frame Color Oak & White Item Number 311345 (O) 308426 (W)	<b>Model</b>   VR369L	<b>Model</b>   VR36AT	<b>Model</b>   VR949	<b>Model</b>   VR48

							
<b>Model</b>   VR64	<b>Model</b>   VR80	<b>Model</b>   VR815	<b>Model</b>   VR836 Size 8"x36" IG Color 1" Low-E Frame Type Evolve Frame Color Oak & White Item Number 311375 (O) 311367 (W)	<b>Model</b>   VR8363L	<b>Model</b>   VR48	<b>Model</b>   VR64	<b>Model</b>   VR880

 **IN STOCK** | 
  **SPECIAL ORDER**

# STREAMED

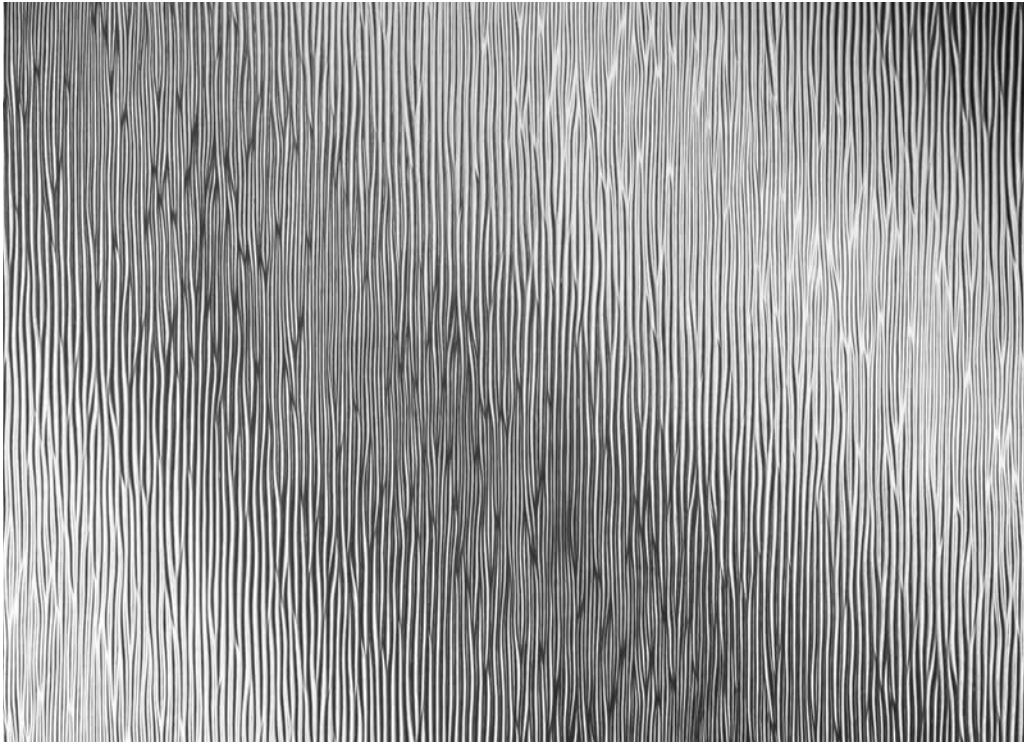

Privacy Rating: **MAXIMUM**



**TEXTURED SURFACE  
EXPOSED TO THE  
INSIDE OF THE HOME**

Available in:  
Fiberglass Smooth  
Fiberglass Fir Textured  
Fiberglass Oak Textured  
Primed Steel

**e** Low - E available

**SDL** Accepts Simulated Divided Lite



Model | VS10A



Model | VSS15



Model | VS153L



Model | VS36



Model | VS48



Model | VS64



Model | VS80



Model | VS836



Model | VS848



Model | VS764



Model | VS880

**IN STOCK** | **SPECIAL ORDER**

# VAPOR



Privacy Rating: **MAXIMUM**



**TEXTURED SURFACE  
EXPOSED TO THE  
INSIDE OF THE HOME**

Available in:  
Fiberglass Smooth  
Fiberglass Fir Textured  
Fiberglass Oak Textured  
Primed Steel

**e** Low - E available



Model | VW15



Model | VW36



Model | VW48  
Size 22"x48"  
IG Color 1" Low-E  
Frame Type Evolve  
Frame Color White  
Item Number 322371 (W)



Model | VW64



Model | VW80



Model | VW836



Model | VW848  
Size 8"x48"  
IG Color 1" Low-E  
Frame Type Evolve  
Frame Color White  
Item Number 322372 (W)



Model | VW764



Model | VW880

IN STOCK
 

 SPECIAL ORDER

# VENTLITE



Fiberglass 1/2 lite in Pure White with 6 lite ventlite glass

## VENTLITE:

- Energy Efficient Doorglass
- Available in Clear OR Rainglass
- Ergonomic latches adjust to 10 positions
- UV resistant SolarShield frame
- Includes screen
- 20 year warranty

## CAMING



White

## GLASS TEXTURE



Clear



Rain



Low-E Available

SPECIAL ORDER



Model | VT2236CLEAR

SPECIAL ORDER



Model | VT2236RAIN

SPECIAL ORDER



Model | VT2236GBG



IN STOCK



SPECIAL ORDER

# Additional Stylized Doorglass

Transform your entry and elevate your home's curb appeal with our exquisite stylized doorglass. Discover a variety of patterns and textures that perfectly complement any architectural style. Let our stylized doorglass redefine your entrance while inviting natural light to enter in.

## Decorative

**ASHBURY**



Max Privacy

**BAY POINT**



Medium Privacy

**CADENCE**



Medium Privacy

**CALANDRA**



High Privacy

**CARROLLTON**



Low Privacy

**COURTYARD**



Max Privacy

**CROSSWALK**



High Privacy

**CYNDI**



Max Privacy

**DITTO**



High Privacy

**DORIAN**



High Privacy

**EDGEWOOD**



Max Privacy

**ELEGANT STAR**



Low Privacy



Max Privacy

**FRAGRANCE**



Max Privacy

**GENEVA**

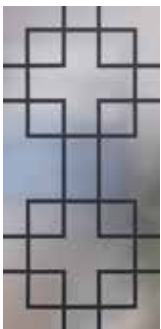

Max Privacy

**HEIRLOOMS**



Medium Privacy

**HIGH POINT**



High Privacy

**JACINTO**



High Privacy

**JAMESTON**



Medium Privacy

**LONDON**



Medium Privacy

**MAJESTIC**



Medium Privacy

**MARGATE**



Max Privacy

**METRO**



Max Privacy

**MOHAVE**



Medium Privacy

**OAK PARK**



Low Privacy

# Decorative

**PARIS**



Medium Privacy

**RENEWED IMPRESSIONS**



Medium Privacy

**RIVERWOOD**



Max Privacy

**STERLING**



High Privacy

**TOPAZ**



Max Privacy

**VILANO**



High Privacy

**WATERSIDE**



High Privacy



*Fiberglass full lite in Coal Black with Bay Point glass*

# Privacy + Textured

**BAROQUE**



Low Privacy

**CELEBRATION OCEAN**



Low Privacy

**KARMA**



Low Privacy

**LINEN**



Max Privacy

**MISTIFY BLACK**



Low Privacy



To view all styles, sizes, and designs available visit:  
[cincinnati.dykedoors.com/resources/helpful-links](http://cincinnati.dykedoors.com/resources/helpful-links)  
 and select *Additional Doorglass Product Catalog*  
 Or, use a mobile device to scan the QR code

# CLEAR



*Fiberglass full lite in Sandpaper Beige with clear glass*



CL2210



CL10B



CL10A



CL15



CL36



CL362P



CL48



CL482P



CL480V



CL480V2P



CL640V



CL64



CL80



CL836



CL848



CL8480



CL764



CL880



CLRE



WSR - CLTRR

 Low-E Available

# DIRECT-SET SIDELITE



*Fiberglass flush door and direct set sidelites in Coal Black with Vapor glass*

## Maximize The Natural Light

- Direct-Set sidelite glass has clean lines and a simple design to maximize natural light in your home.
- Up to 30% more light
- Create an open and airy feeling
- Double panes of Low-E safety built directly into the door system to protect the inside of the home
- Engineered to perform
- Backed by a comprehensive Dyke Industries Warranty, you can be sure your investment will last



DSSL68



DSSL80



*Fiberglass full lite door and direct set sidelites in Nightfall with clear glass*

 Low-E Available

# RAISE/LOWER TILT INTERNAL BLINDS

The 20 year warranty Raise/Lower Tilt Blinds bring an updated look and finish to your entryway while also keeping the same benefits of maintenance-free light and privacy control of enclosed blinds. Internal blinds bring long-lasting reliability.



## LOW MAINTENANCE

- Enclosed blinds means no more dusting and decreased allergens in your home
- Longer lasting blinds that won't bend or tangle over time
- 20-year warranty on blinds, glass, and seal operator

## SAFETY

- Safer for children and pets
- With no dangling cords, blinds received certifications from Window Covering Manufactures Association and Parents for Window Blind Safety
- All blinds include tempered safety glass



## ATTENTION TO DETAIL

- Six color options to match all home decor
- Cords covered with bottom rail
- Matching components

## LIGHT AND PRIVACY CONTROL

- Tilt blinds completely closed for privacy
- Fully open blinds to enjoy the view
- Full privacy channels erase light gaps, shadows and sunlight glare

## EASY TO OPERATE

- No reaching, yanking, or stooping needed to adjust blinds
- Operator glides along the track and adjust blinds with minimal movement



## STANDARD COLORS

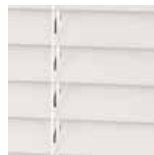

White

## PREMIUM COLORS

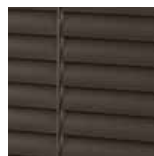

Espresso

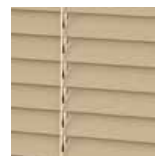

Sand



Slate Gray



Silver Moon

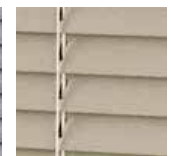

Tan

# RAISE/LOWER TILT BLINDS



Fiberglass full lite in Snow Mist with Raise/Lower Tilt Blinds

Privacy Rating:



## BLIND COLORS

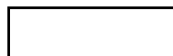

White

## GRILLE OPTIONS



Standard White  
Contoured Bar

## GLASS TEXTURE



Clear



Low-E Glass



## What makes Blink® the perfect IG (insulated glass) panel with built-in blinds? It's all inside...

1. Cordless blinds between glass: no exposed cords makes the blinds safe for children and pets
2. Color-coordinated components match frames and home decor
3. Low-E and Dual Low-E options available to meet your energy needs
4. Contemporary fingertip controller for raise, lower, tilt functions

# RAISE/LOWER TILT BLIND COLORS

## STANDARD COLORS

### WHITE



Fiberglass full lite in Pure White with White RLT blinds



## PREMIUM COLORS

### ESPRESSO



Fiberglass 1/2 lite in White Christmas with Espresso RLT blinds

### SAND



Fiberglass full lite in White Christmas with Sand RLT blinds



RLT36B

RLT48B

RLT64B



RLT36S

RLT48S

RLT64S

Special Order

# PREMIUM COLORS

## SILVER MOON



Fiberglass 1/2 lite in Sterling Gray with Silver Moon RLT blinds



RLT36SM

RLT48SM

RLT64SM

## SLATE GRAY



Fiberglass full lite in Sandstone with Slate Gray RLT blinds



RLT36G

RLT48G

RLT64G

RLT864G

## TAN



Fiberglass full lite in Clay with Tan RLT blinds



RLT36T

RLT64T

RLT80T

RLT864T

RLT880T

Special Order

# RAISE/LOWER TILT BLINDS WITH GBG

Privacy Rating:



## BLIND COLORS

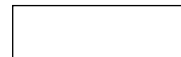

White

## GRILLE OPTIONS



Standard White  
Contoured Bar

## GLASS TEXTURE



Clear

*GBG: Grilles between glass*

*Fiberglass full lite in White Christmas with RLT blinds GBG 15 Lite*



Fiberglass full lite in Chateau with RLT blinds GBG 15 Lite



Fiberglass 1/2 lite in White Christmas with RLT blinds GBG 6 Lite



RLTGBG36



RLTGBG48



RLTGBG64

# GRILLES BETWEEN GLASS



Fiberglass full lite in Coal Black with flat black GBG 10 lite

## GBG Color Options



White Flat Bar



Beige Flat Bar



Champagne Flat Bar



Bronze Flat Bar



2-Tone Flat Bar  
Bronze/White



Black Flat Bar



Grilles Between Glass  
5/8" Flat Bars



GBG1



GBG2



GBG3



GBG-2P



GBG4



GBG4-2P

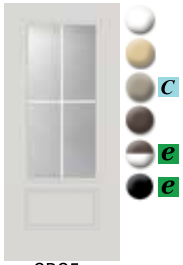

GBG5

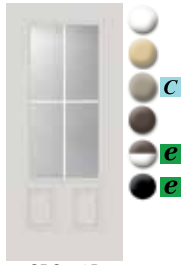

GBG5-2P



GBG6



GBG6-2P



GBG7



GBG7-2P

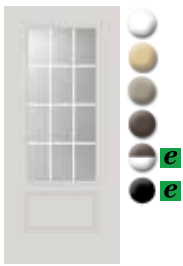

GBG8

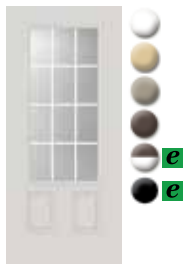

GBG8-2P

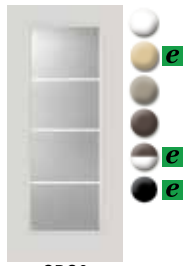

GBG9

Also Available in 8/0

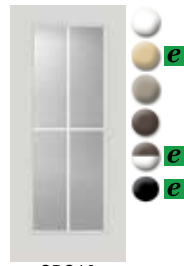

GBG10

Also Available in 8/0

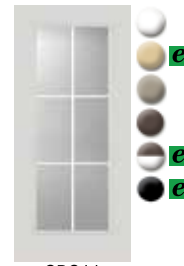

GBG11

Also Available in 8/0

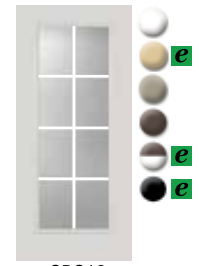

GBG12

Also Available in 8/0

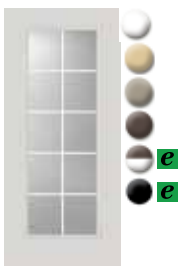

GBG13

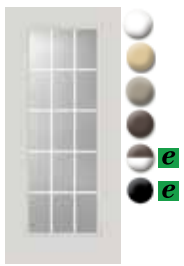

GBG14



GBGS1

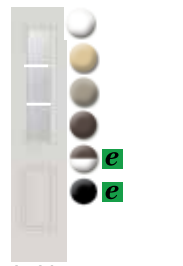

GBGS2



GBGS3

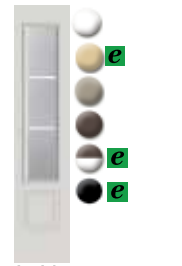

GBGS4

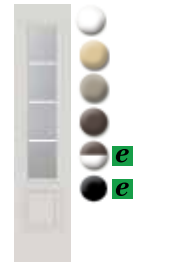

GBGS5



GBGS6



GBGS7



GBGS8

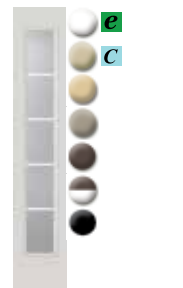

GBGS9



GBGS5

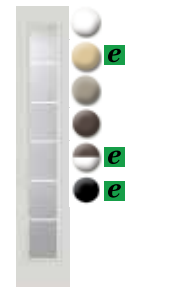

GBGS6

**e** Low-E Glass Only

**C** Clear Glass Only

# EXTERNAL GRILLES



Fiberglass 3/4 lite in White Christmas with 12 lite external grilles and clear glass

## EXTERNAL GRILLES

- Energy Efficient Doorglass
- Includes Craftsman sizes
- 27/32" wide external contoured bar
- 7/8" wide external Craftsman bar
- Craftsman doorlites shown fit select Craftsman door styles only



Fixed Grilles available in White

## GRILLE OPTIONS



Standard White Contoured Bar

## GLASS TEXTURE



Clear



Low-E Glass



EG1



EG2



EG3  
Raised Panel Sticking



EG4  
Raised Panel Sticking



EG5



EG5-2P



EG6



EG6-2P



EG7



EG8



EG9



EG10



EG11



EG12



EG13



EG14



EG16



EG17

# PATIO DOORS

*Bring the Outside In*



## PATIO DOOR SOLUTIONS

*Fiberglass full lite in Pure White with 15 lite external grilles*



Complement your outdoor living space with a patio door that combines durability, function, security and aesthetic appeal. Feel safe knowing Dyke patio doors are built from the same reliable construction as the single entry doors. Choose from 2 or 3 lite configurations then add sidelites and a transom to increase natural light while adding your own distinctive style.

## VERSATILE SELECTIONS

Dyke Industries offers hinged patio doors that are functional, durable, and provide the aesthetic appeal that will complement your Dyke Industries front door. Our hinged patio doors are available as 2 or 3 lite units, with many of the same options as single entry doors. The selections for panel style, woodgrain or smooth texture, and various glass options make virtually endless options!

### Low-E Glass



WD	HGT
5'0"	6/8
5'4"	7/0
5'8"	8/0
6'0"	

#### Available Configurations

\*Available Retro Fit Size

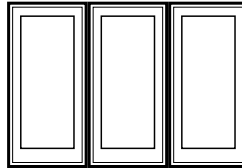
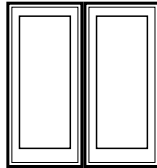

### Grilles



WD	HGT
5'0"	6/8
5'4"	7/0
5'8"	8/0
6'0"	

#### Available Configurations

\*Available Retro Fit Size

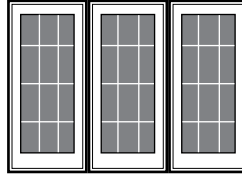
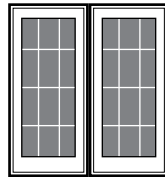

\*Available in 10 lite, 12 lite, 15 lite, and 18 lite

### Internal Blinds



WD	HGT
5'0"	6/8
5'4"	7/0
5'8"	8/0
6'0"	

#### Available Configurations

\*Available Retro Fit Size

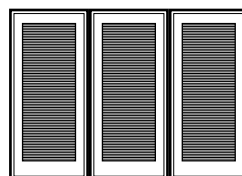
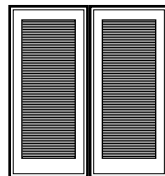

Double Door  
French Opening

Center Hinge  
Patio OSOI  
Right Active

Center Hinge  
Patio OSOI  
Left Active

Inactive - Center Active - Inactive  
OSOI Inswing

Inactive - Inactive -  
RH Active OSOI Inswing

LH Active - Inactive -  
Inactive OSOI Inswing

## SMOOTH FIBERGLASS

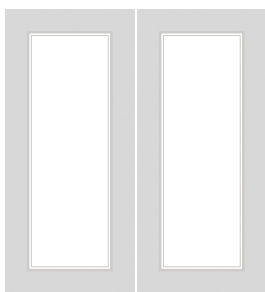

2264

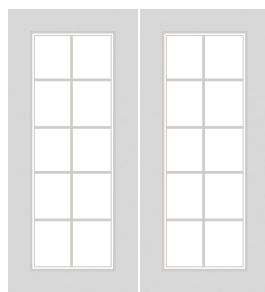

2264 10L

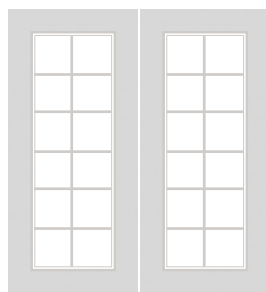

2264 12L

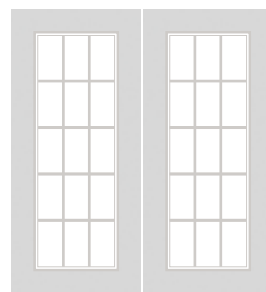

2264 15L

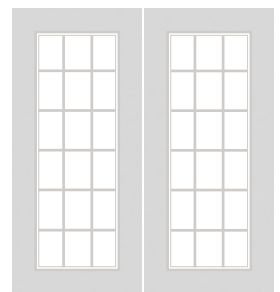

2264 18L

# PUSH BUTTON OPERATION

## ULTIMATE PUSH BUTTON ASTRAGAL DUAL-PUSH OPERATION. ENHANCED PERFORMANCE.

The Ultimate Push Button Astragal delivers enhanced sealing power and added built-in security in a solution that's easy to use, operating with the simple push of a button.

- ▶ **Dual-Push Operation:** Spring-loaded bolts automatically engage with the simple push of a button and conveniently retract with one easy motion.
- ▶ **Enhanced Standard Security:** Spring-loaded 24" bolt automatically secures the unit with a push of a button for ultimate security and peace of mind. Push a button. Secure your door. It's that easy.
- ▶ **Extended Sealing Power:** Protects your home from infiltration with 4 weather-sealing components working together. Spring-loaded floating boot forms a custom weathertight seal and works with the Simple Solution Corner Pad to seal leaks at the base of the unit. When the bolt is retracted, the floating boot lifts clear of the sill protecting against wear and damage and guaranteeing a secure seal over time. Full-length sealing fin works along with the weatherstrip to fight infiltration from top to bottom.
- ▶ **Easy Hardware Customization:** Meeting custom hardware needs has never been easier with the Ultimate Push Button Astragal's innovative strike retainer design. Strike retainer can be easily removed, resized, repositioned, or replaced to accommodate many hardware styles and sizes.

## ALUMINUM & WOOD VENEER FINISHES



White\*    Bronze\*    Mill\*\*    Alder\*    Clear Fir\*    Clear Pine\*    Mahogany\*    Oak\*

\*Also available in Compatible Options    \*\*Non-thermal Only



## HOW DOES IT WORK?

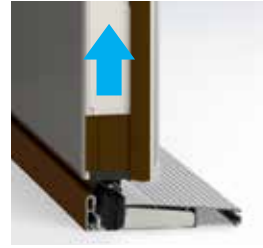

### PUSH BUTTON TO ENGAGE

Each Spring-loaded Bolt is activated with an easy push of a button. The Spring-loaded Floating Boot securely seals, independently of the bolt, against the sill fighting air and water infiltration, even in imperfect conditions.

### RETRACT WITH ONE EASY MOTION

Each Spring-loaded Bolt retracts with one easy motion and the Spring-loaded Floating Bolt lifts clear of the sill preventing wear and damage for problem-free use of the inactive door.

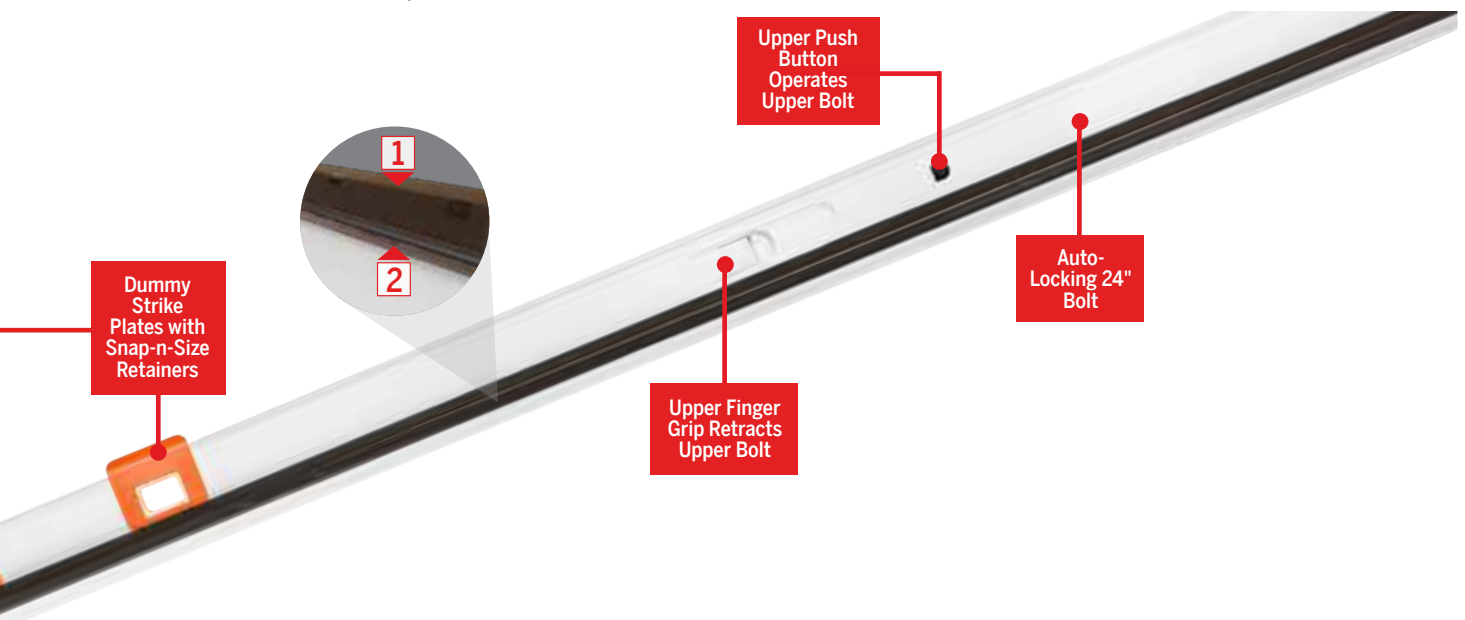

## SNAP-N-SIZE™ STRIKE RETAINERS: HOW DO THEY WORK?



### REMOVE

Innovative strike retainer design allows effortless removal from the astragal. Simply snap out to remove. No extra steps required.



### RESIZE

Built-in break lines allow easy resizing. No tools necessary.



### REPLACE AND REPOSITION

Snap the strike retainer pieces into the astragal and position as needed to meet your hardware needs.

# RETROFIT SILL DECK

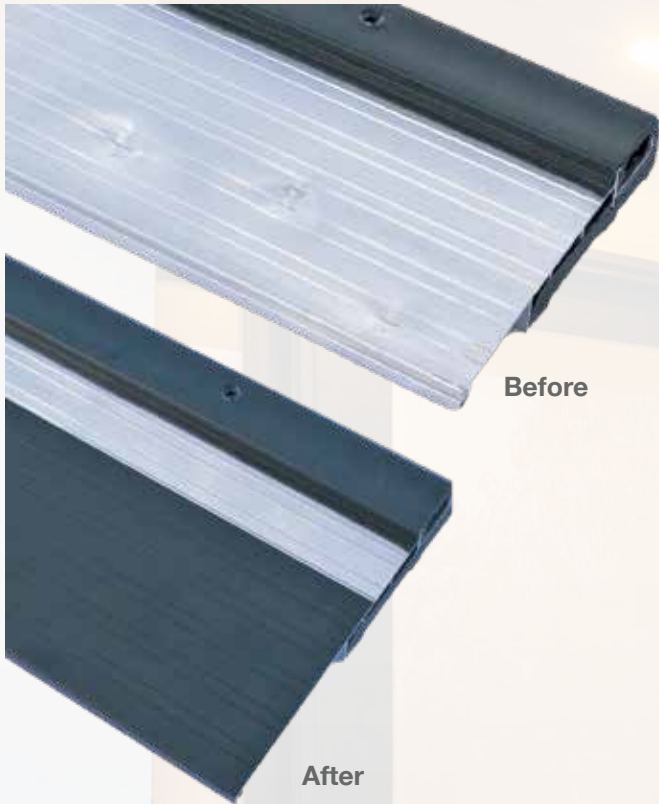

Before

After

## ACCIDENTS HAPPEN

A dropped hammer.  
An aggressive snow shovel.  
A moving company in too big of a hurry with the refrigerator.

Accidents like these can leave you with a damaged sill deck detracting from the beauty of your home's entrance. As concerning as this damage might be, there's no need to tear out the entire threshold.

## The Solution: iXo Retrofit Sill Deck

An extruded aluminum sill deck overlay that snaps into the nosing interlock of The iXo Sill. The back edge tucks in under the flexible nose of the riser providing a clean, complete look.

## COLOR CHANGE IN A SNAP

Remodeling projects bring new accent finishes. If your entrance's color scheme needs to change from a Stain Nickel to a Dark Bronze or vice versa, The iXo Retrofit Sill Deck can be your exterior decor solution. Your iXo Sill doesn't have to be damaged to apply the Retrofit Sill Deck for a fashionable update.

## RETRO FIT FEATURES

- Secure Channel Lock
- Interlocking treads that line up with treads of existing sill deck



★ PROUDLY  
AMERICAN MADE ★

# iXo DOOR SILL

The iXo Sill is a premium threshold with an easily interchangeable riser and full composite substrate.

## iXo SILL FEATURES

- Flush Mount Riser Adjustment Screws
- High Dam Sill Plate
- SureSeal Gasket
- Full Composite Substrate
- Aluminum Riser Channel
- Embossed Synthetic Rider and Nosing



## iXo SILL OUTSWING PROFILES

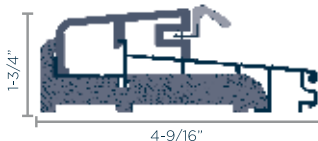

**XO4916**

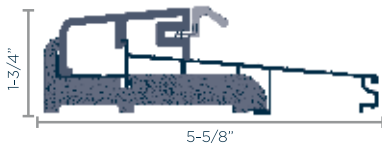

**XO558**

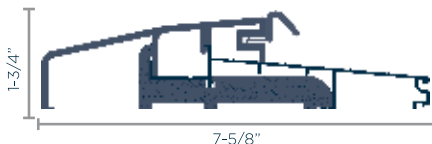

**XO758**

## iXo ADA SILL

ADA sills provide a durable solution for accessibility focused entryways.



**ADA Sill with Thermal Break**

★ PROUDLY AMERICAN MADE ★



*Fiberglass full lite and sidelites in Coal Black with Pembrook glass*

# COMPOSITE FRAMES AND COMPONENTS

Our composite door frames set the standard for performance. They are low-maintenance, easy to clean and paint, and built to last, making them the ideal solution for homeowners.

## SMOOTH PRIMED COMPOSITE



- A poly-fiber door frame system that combines all the strength and convenience of wood with enhanced properties that make it moisture, rot, and insect resistant
- Machined the same way as traditional wood jambs, but with twice the screw-holding power
- Closed cellular structure that prevents warping, rotting, and splitting

## SMOOTH WHITE CAPPED COMPOSITE



- Doesn't require paint
- A poly-fiber door frame system that combines all the strength and convenience of wood with enhanced properties that make it moisture, rot, and insect resistant
- Machined the same way as traditional wood jambs, but with twice the screw-holding power
- Closed cellular structure that prevents warping, rotting, and splitting

## ROT RESISTANT FRAME



- Technology used for over 25 years
- Alaskan Yellow Cypress includes natural compounds resistant to rot, decay, mold, fungus, and insect attacks
- These natural compounds are long lasting and do not wash out. They have known to last over hundreds of years

## FRAME COMPARISONS



**Traditional Wood Frame**  
Wood will rot and warp overtime leading to a weakened frame and weather and insect infiltration

VS.



**Composite Frame**  
Designed to hold up long-term against unwanted outdoor infiltration with a closed cellular structure and poly-fiber cover.

OR



**Rot Resistant Frame**  
Includes long-lasting and durable natural compounds with rot resistant properties.

# PRODUCT LINE OVERVIEW



4-9/16" Door Jamb



5-1/4" Door Jamb



6-9/16" Door Jamb



7-1/4" Door Jamb



Jamb Extension



WM180 Brick Mould



Transom Sills  
4-9/16"  
6-9/16"



Mull Posts  
1-1/2" x 3-9/16" x 2 1/2"  
1-1/2" x 4-3/8" x 2 1/2"  
1" x 3-9/16" x 2"  
1" x 4-3/8" x 2"



Flat Casting



Mull Post Covers  
1-1/2" x 1"  
2" x 1"



Storm Door Adapters



Painted Aluminum Astrigal



*Fiberglass 1 lite in Sandstone with Streamed glass*

# DOORGLASS FRAMES

We offer a dynamic array of doorglass frames, styles, colors and materials to meet specific needs.

## PERFORMANCE



**Evolve®**  
WHITE OR OAK

### FEATURES/BENEFITS

- Design to be painted or stained
- Dry glaze seal
- Best defense against air and water infiltration
- Auto-Aligning screw hole covers
- FiberPro material does not require primer or finishing
- Unique construction helps reduce scalloping and corner flare

## SPECIALTY



**Craftsman®**  
WHITE, OAK, OR MAHOGANY

### FEATURES/BENEFITS

- FiberMate material can be painted or stained without adhesion promoter
- Dry glaze seal
- Heat tolerant to reduce warping in high-heat areas
- Hidden screw covers
- Best defense against air and water infiltration
- Unique construction helps reduce scalloping and corner flare while blending with the door style

Feature/Benefit	Evolve White	Craftsman
Frame Material	FiberPro	FiberMate
Compression Seal No Squeeze Out	✓	✓
Designed to Reduce Scalloping		✓
Best Defense Against Air and Water Infiltration	✓	✓
Hidden Screws		✓
Auto-Aligning Screw Covers	✓	
Heat Tolerant		✓
Paints Without Adhesion Promoter		✓
Stainable		✓
No Finishing Required	✓	





*Fiberglass 3/4 lite and full lite sidelite in Geneva Blue with Micro-Granite glass*

# PANOLOCK MULTIPOINT



## MULTI-POINT LOCK

### THE NEW GENERATION OF MULTIPOINT LOCKS

PanoLock is one-of-a-kind multi-point lock that works with off-the-shelf hardware, supports a forgiving installation, and offers lasting performance, all at an affordable price point.

- Install a broad range of styles at a more affordable price
- Make hardware selections when it works for you - not when you specify doors
- Match hardware designs on other doors
- Affordably and simply change hardware at any time





### CHOOSE YOUR HARDWARE

Whether knob, lever, or thumbpress, PanoLock is compatible with many off-the-shelf hardware.

### A MULTI-POINT LOCK FOR EVERY BUDGET

Available at a more approachable price point so you can use PanoLock for more projects (and budgets).

### SMOOTH LOCKING OPERATION

Supports a more forgiving install and smoother everyday use with tapered bolts and adjustable roller strikes

### THE STRENGTH AND SECURITY OF A MULTI-POINT LOCK

Enjoy enhanced performance and security with three locking points.

### HOW IT WORKS

PanoLock Plus works with standard hardware via innovative plug-n-play handleset and deadbolt adapters that mate with multiple brands and styles. Including electronic deadbolts.

Current tested compatible brands include: Schlage, Kwikset, Emtek, Defiant, Reliablit, and others being tested every day. No dedicated hardware required.



Use your desktop computer to visit endura for compatible handlesets by brand:

[www.enduraproducts.com/panolock-2](http://www.enduraproducts.com/panolock-2)



For compatible handle-set brands and installation videos, point the camera of your mobile device over this code to provide a link.

# HARDWARE & COMPONENTS

## HINGES

Durable steel hinges for the three or four pivot points.

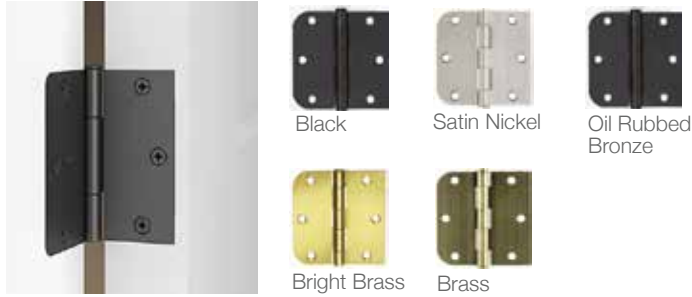

## DOOR KNOCKERS

The two elegant designs blend style and function.



## PEEP SIGHT VIEWERS

An extra touch of safety to view visitors from inside your home.



 Available Fire Rated

## SPEAK EASY

Built with heavy gauge steel, these viewers create dimension for your door while also protecting the viewer.

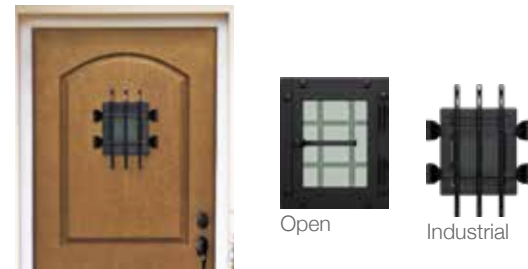

## CLAVOS

For long-lasting durability, our clavos are made from thick cast zinc to prevent rust.

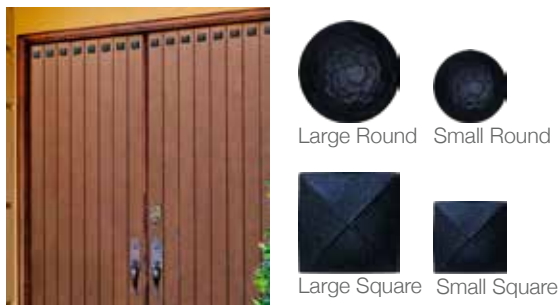

## HINGE STRAPS

Flush-mounted iron straps create a rustic aesthetic to doors.



## MAIL SLOTS

Spring loaded flap swings out and includes a matching plate for interior slot.



## KICK PLATES

Protect the bottom of your door from scuffs, scratches, and daily wear.

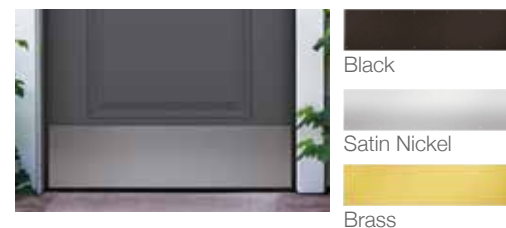

## DENTIL SHELF



3 or 4 Block Textured Dentil Shelf  
OAK OR RUSTIC



3 or 4 Block Textured Dentil Shelf  
SMOOTH

## SECURITY PLATE



20 Gauge Security Plate

## BLADE SWEEP



Dual Bulb

## WEATHERSTRIPPING



Energy efficient seal for top and sides of door

## DUST BOX



Blocks air infiltration

## SILL COVER



## SILL PAN



## PET DOOR

Includes 3 insulating pet flaps with magnetic seals to prevent drafts. Made with a premium, durable aluminum material to withstand any weather.



Medium  
8.25" x 12.25"  
opening for pets  
up to 40 lbs

Large  
10.25" x 16.25"  
opening for pets  
up to 100lbs

X-Large  
13.75" x 23.75"  
opening for pets  
up to 220lbs



Fiberglass and Steel Applicable



Interior Applications



Alternative Applications

# SPECIFICATIONS

## EXTERIOR DOOR SIZES

6/8 SINGLE UNIT

Door Size	Unit Dimension	Rough Opening	Masonry Opening
2-0 x 6-8	25-1/2 x 81-3/4	26 x 82-1/4	28 x 83
2-6 x 6-8	31-1/2 x 81-3/4	32 x 82-1/4	34 x 83
2-8 x 6-8	33-1/2 x 81-3/4	34 x 82-1/4	36 x 83
2-10 x 6-8	35-1/2 x 81-3/4	36 x 82-1/4	38 x 83
3-0 x 6-8	37-1/2 x 81-3/4	38 x 82-1/4	40 x 83

7/0 SINGLE UNIT

Door Size	Unit Dimension	Rough Opening	Masonry Opening
2-0 x 7-0	25-1/2 x 85-3/4	26 x 86-1/4	28 x 87
2-6 x 7-0	31-1/2 x 85-3/4	32 x 86-1/4	34 x 87
2-8 x 7-0	33-1/2 x 85-3/4	34 x 86-1/4	36 x 87
2-10 x 7-0	35-1/2 x 85-3/4	36 x 86-1/4	38 x 87
3-0 x 7-0	37-1/2 x 85-3/4	38 x 86-1/4	40 x 87

8/0 SINGLE UNIT

Door Size	Unit Dimension	Rough Opening	Masonry Opening
2-0 x 8-0	25-1/2 x 97-3/4	26 x 98-1/4	28 x 99
2-6 x 8-0	31-1/2 x 97-3/4	32 x 98-1/4	34 x 99
2-8 x 8-0	33-1/2 x 97-3/4	34 x 98-1/4	36 x 99
2-10 x 8-0	35-1/2 x 97-3/4	36 x 98-1/4	38 x 99
3-0 x 8-0	37-1/2 x 97-3/4	38 x 98-1/4	40 x 99

6/8 SINGLE  
W/1 SIDE LITE

Door Size	Unit Dimension	Rough Opening	Masonry Opening
3-0 x 6-8 x 1-0	51 x 81-3/4	51-1/2 x 82-1/4	53-1/2 x 83
3-0 x 6-8 x 1-2	53 x 81-3/4	53-1/2 x 82-1/4	55-1/2 x 83

7/0 SINGLE  
W/1 SIDE LITE

Door Size	Unit Dimension	Rough Opening	Masonry Opening
3-0 x 7-0 x 0-10	49 x 85-3/4	49-1/2 x 86-1/4	51-1/2 x 87
3-0 x 7-0 x 1-0	51 x 85-3/4	51-1/2 x 86-1/4	53-1/2 x 87
3-0 x 7-0 x 1-2	53 x 85-3/4	53-1/2 x 86-1/4	55-1/2 x 87

8/0 SINGLE  
W/1 SIDE LITE

Door Size	Unit Dimension	Rough Opening	Masonry Opening
3-0 x 8-0 x 1-0	51 x 97-3/4	51-1/2 x 98-1/4	53-1/2 x 99
3-0 x 8-0 x 1-2	53 x 97-3/4	53-1/2 x 98-1/4	55-1/2 x 99

6/8 DOUBLE UNIT

Door Size	Unit Dimension	Rough Opening	Masonry Opening
4-0 x 6-8	50 x 81-3/4	50-1/2 x 82-1/4	52-1/2 x 83
5-0 x 6-8	62 x 81-3/4	62-1/2 x 82-1/4	64-1/2 x 83
5-4 x 6-8	66 x 81-3/4	66-1/2 x 82-1/4	68-1/2 x 83
6-0 x 6-8	74 x 81-3/4	74-1/2 x 82-1/4	76-1/2 x 83

7/0 DOUBLE UNIT

Door Size	Unit Dimension	Rough Opening	Masonry Opening
4-0 x 7-0	50 x 85-3/4	50-1/2 x 86-1/4	52-1/2 x 87
5-0 x 7-0	62 x 85-3/4	62-1/2 x 86-1/4	64-1/2 x 87
5-4 x 7-0	66 x 85-3/4	66-1/2 x 86-1/4	68-1/2 x 87
6-0 x 7-0	74 x 85-3/4	74-1/2 x 86-1/4	76-1/2 x 87

8/0 DOUBLE UNIT

Door Size	Unit Dimension	Rough Opening	Masonry Opening
4-0 x 8-0	50 x 97-3/4	50-1/2 x 98-1/4	52-1/2 x 99
5-0 x 8-0	62 x 97-3/4	62-1/2 x 98-1/4	64-1/2 x 99
5-4 x 8-0	66 x 97-3/4	66-1/2 x 98-1/4	68-1/2 x 99
6-0 x 8-0	74 x 97-3/4	74-1/2 x 98-1/4	76-1/2 x 99

6/8 SINGLE  
W/2 SIDE LITES

Door Size	Unit Dimension	Rough Opening	Masonry Opening
0-10 x 3068 x 0-10	60-1/2 x 81-3/4	61 x 82-1/4	63 x 83
1-0 x 3068 x 1-0	64-1/2 x 81-3/4	65 x 82-1/4	67 x 83
1-2 x 3068 x 1-2	68-1/2 x 81-3/4	69 x 82-1/4	71 x 83

7/0 SINGLE  
W/2 SIDE LITES

Door Size	Unit Dimension	Rough Opening	Masonry Opening
0-10 x 3070 x 0-10	60-1/2 x 85-3/4	61 x 86-1/4	63 x 87
1-0 x 3070 x 1-0	64-1/2 x 85-3/4	65 x 86-1/4	67 x 87
1-2 x 3070 x 1-2	68-1/2 x 85-3/4	69 x 86-1/4	71 x 87

8/0 SINGLE  
W/2 SIDE LITES

Door Size	Unit Dimension	Rough Opening	Masonry Opening
0-10 x 3080 x 0-10	60-1/2 x 97-3/4	61 x 98-1/4	63 x 99
1-0 x 3080 x 1-0	64-1/2 x 97-3/4	65 x 98-1/4	67 x 99
1-2 x 3080 x 1-2	68-1/2 x 97-3/4	69 x 98-1/4	71 x 99

June 2025

**6/8 DOUBLE DOOR PATIO**

Door Size	Unit Dimension	Rough Opening	Masonry Opening
5-0 x 6-8	63 x 81-3/4	63-1/2 x 82-1/4	65-1/2 x 83
5-4 x 6-8	67 x 81-3/4	67-1/2 x 82-1/4	69-1/2 x 83
6-0 x 6-8	75 x 81-3/4	75-1/2 x 82-1/4	77-1/2 x 83

**7/0 DOUBLE DOOR PATIO**

Door Size	Unit Dimension	Rough Opening	Masonry Opening
5-0 x 7-0	63 x 85-3/4	63-1/2 x 86-1/4	65-1/2 x 87
5-4 x 7-0	67 x 85-3/4	67-1/2 x 86-1/4	69-1/2 x 87
6-0 x 7-0	75 x 85-3/4	75-1/2 x 86-1/4	77-1/2 x 87

**8/0 DOUBLE DOOR PATIO**

Door Size	Unit Dimension	Rough Opening	Masonry Opening
5-0 x 8-0	63 x 97-3/4	63-1/2 x 98-1/4	65-1/2 x 99
5-4 x 8-0	67 x 97-3/4	67-1/2 x 98-1/4	69-1/2 x 99
6-0 x 8-0	75 x 97-3/4	75-1/2 x 98-1/4	77-1/2 x 99

**6/8 TRIPLE DOOR PATIO**

Door Size	Unit Dimension	Rough Opening	Masonry Opening
7-6 x 6-8	94-1/2 x 81-3/4	95 x 82-1/4	97 x 83
8-0 x 6-8	100-1/2 x 81-3/4	101 x 82-1/4	103 x 83
9-0 x 6-8	112-1/2 x 81-3/4	113 x 82-1/4	115 x 83

**7/0 TRIPLE DOOR PATIO**

Door Size	Unit Dimension	Rough Opening	Masonry Opening
7-6 x 7-0	94-1/2 x 85-3/4	95 x 86-1/4	97 x 87
8-0 x 7-0	100-1/2 x 85-3/4	101 x 86-1/4	103 x 87
9-0 x 7-0	112-1/2 x 85-3/4	113 x 86-1/4	115 x 87

**8/0 TRIPLE DOOR PATIO**

Door Size	Unit Dimension	Rough Opening	Masonry Opening
7-6 x 8-0	94-1/2 x 97-3/4	95 x 98-1/4	97 x 99
8-0 x 8-0	100-1/2 x 97-3/4	101 x 98-1/4	103 x 99
9-0 x 8-0	112-1/2 x 97-3/4	113 x 98-1/4	115 x 99

**HINGE AND BORE LOCATIONS FROM TOP OF DOOR**

6/8 and 7/0		8/0	
<b>Top Hinge</b>	6 1/2" to top of hinge	<b>Top Hinge</b>	6-1/2" to top of hinge
<b>Mid Hinge</b>	37 1/2" to top of hinge	<b>2<sup>nd</sup> Hinge</b>	32 1/2" to top of hinge
<b>Bottom Hinge</b>	68 1/2" to top of hinge	<b>3<sup>rd</sup> Hinge</b>	58 1/2" to top of hinge
<b>Lock Bore</b>	45 7/8" to center of bore	<b>4<sup>th</sup> Hinge</b>	84-1/2" to top of hinge
<b>Dead Bolt Bore</b>	40 3/8" to center of bore	<b>Lock Bore</b>	60" to center of bore
		<b>Dead Bolt Bore</b>	54-1/2" to center of bore

**RETRO SIZES**

Unit	Unit Dimension
Patio 5/0 x 6/8	59-1/2 x 79-3/4
Double 5/0 x 6/8	59 x 79-3/4
Patio 6/0 x 6/8	71-1/2 x 79-3/4
Double 6/0x 6/8	71 x 79-3/4

**IDP Split Metal Frame R/O's**

3/0 6/8 ADA = 37-1/4" x 80-1/2"
3/0 6/8 ADJ = 37-1/4" x 81-1/4"
3/0 7/0 ADA = 37-1/4" x 84-1/2"
3/0 7/0 ADJ = 37-1/4" x 85-1/4"
3/0 8/0 ADA = 37-1/4" x 96-1/2"
3/0 8/0 ADJ = 37-1/4" x 97-1/4"

All split metal frames are given as rough opening only. Contact your sales rep for other dimensions as needed.

**MISCELLANEOUS**

DEDUCT	SLAB SIZE
Outswing units deduct 3/4" from height	2-0 x 6-8 23-3/4 x 79
ADA sill units deduct 7/8" from height	2-6 x 6-8 29-3/4 x 79
	2-8 x 6-8 31-3/4 x 79
<b>ADD</b>	3-0 x 6-8 35-3/4 x 79
10" transoms add 11-1/2" to height	
12" transoms add 13-1/2" to height	
<b>Standard peep height:</b> 21" measured top down	<b>ADA peep height:</b> 36" measured top down



June 2025

# INSTALLATION

## EXTERIOR DOOR UNIT INSTALLATION INSTRUCTIONS

### Single Door Installation

Note: to install double door units and doors with sidelite(s) see 'Additional Instructions'.

#### Step 1: Prepare Rough Opening

- For rough opening dimensions, measure the prehung unit from outside jamb to outside jamb. Add 1/2" to width and 3/4" to height to determine rough opening. If opening is oversized, fillers/shims may be required. (Rough opening sizes are also listed in the full line catalog.)
- Are the framed walls plumb to back and left to right, using a 6' level. - **Figure B.1**
- Is the opening square, check by a "string test". Attach the string diagonally in the opening from the outside corners as shown. The strings must gently touch in the center. An opening out of plumb must be corrected prior to advancing the installation process. - **Figure C.1**

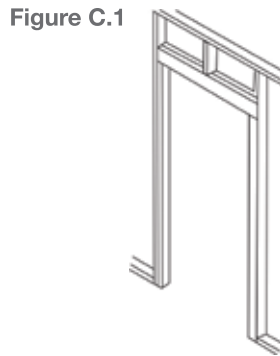
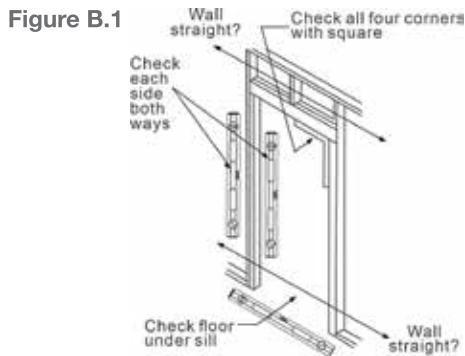

- Verify the sub floor is level? Fill, level and fix as needed for a flat smooth sub floor to set the door.
- Fix any problems at this time before proceeding to install the door unit.

#### Step 2: Place Unit into Opening

- Set the unit into a rough opening to verify fit, then remove.
- Thoroughly caulk floor/base area where the unit will be located with a high-grade silicone or non-hardening caulk. Place three 1/4" beads of caulk across the full width of the sub floor that will be under the sill. - **See Figure A.**  
**Proper caulking is essential:** follow sealant manufacturer's instructions.
- Apply a 1/2" bead of caulk to the backside of the brickmould to ensure a weatherproof barrier.
- Position unit into opening and center by seating the sill down onto the caulk beads then tilting the top of the unit into the opening.  
**Do not fasten through the brickmould.**

**Figure A**

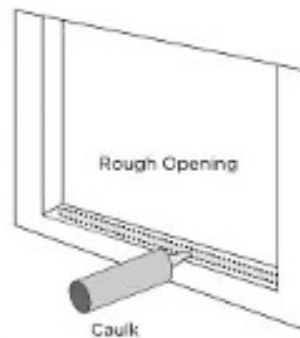

**Step 3: Shim and Secure Hinge Jamb**

- A. Use a 6-foot level and plumb the hinge side jamb both ways (right to left and inside to outside).
- B. Using Minimum 2-1/4" screws, place screws through the hinge side jamb and into the studs, at each hinge location. Do NOT drive the screws completely in at this time. Place screws at each hinge location so shims can be placed behind hinges above screws. **Figure C.**
- C. The screws will keep the shims from falling down while adjustments are being made. For a single unit, fasten the jamb on the hinge side of the door. For units with sidelite(s), fasten the jamb on the hinge side of the door. For double door and patio units, fasten the fixed or passive side of the unit first.
- D. Remove the shipping bracket that holds the door closed. Check to see that the door swings freely.
- E. From the interior side, wedge shims between frame and studding at the three hinge locations and check for plumb - **Figure B.**
- F. Install two (2) security screws (Minimum 2-1/4" screw) in the top hinge.

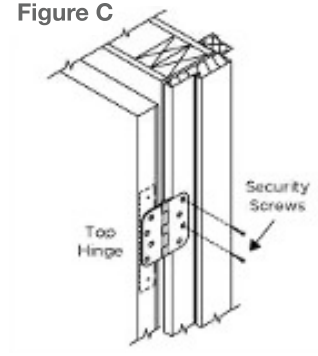
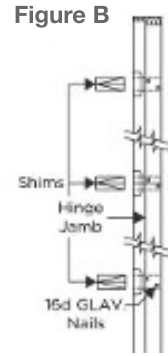

**Step 4: Shim and Secure Lock and Head Jamb**

- A. Close the door and adjust the jamb so the weatherstripping meets the door evenly from top to bottom.
- B. From the inside place a minimum of three wood shims between the frame and the studding at a minimum of three locations on both sides of jamb. It is a requirement to place shims behind the strike plate. - **Figure D.**
- C. Be sure to adjust the three shims to plumb the jamb and provide a 3/16" margin between the door and the jamb - **Figure E.**
- D. Use a 6-foot level and re-check hinge jamb to ensure it is plumb and straight. Finish driving screws tight at this time.
- E. There should be uniform spacing between door and jamb. Check around entire perimeter of door for uniform spacing. Typically, 1/8" reveal is the standard spacing around the head, strike and hinge sides. Make any adjustments now to ensure uniform spacing around the door before proceeding,
- F. Add insulation material to the cavity between the opening and the unit to reduce air infiltration and heat transfer.

For double units:

- G. If the astragal and multi-point shoot-bolts do not fully engage; adjust the holes in the head jamb to accept the shoot-bolt.
- H. Shim above the mull post(s) and or mull jamb(s), pre-drill and insert a screw through the frame into the header, at either side of mull post and or mull jamb(s).

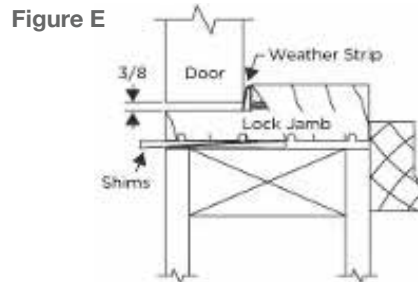
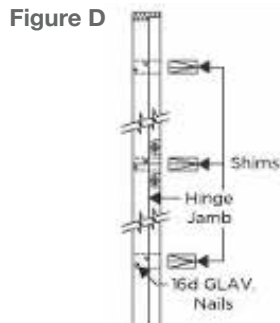

**Step 5: Threshold Cap Adjustment**

- A. If necessary, the threshold cap can be adjusted. Adjustment is accomplished by using a screwdriver to turn the jack screws up or down to adjust the threshold cap to the desired height. **1/8" maximum height adjustment**

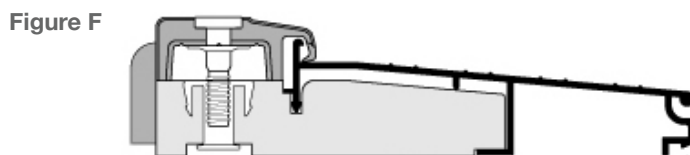

# INSTALLATION

## Step 6: Caulk and Finish Unit

- A. Caulk around the brickmold and the joint between the sill, jamb over the saddle including the mull post when present. Use a high-quality elastomeric (SP) caulk.
- B. Ensure corner seals are securely in place in both lower corners of the unit. The thicker part of the wedge tucks under the weatherstrip – **Figure K**
- C. Putty and fill all screw holes.
- D. Tighten screws around lite frames for a secure weatherproof seal.

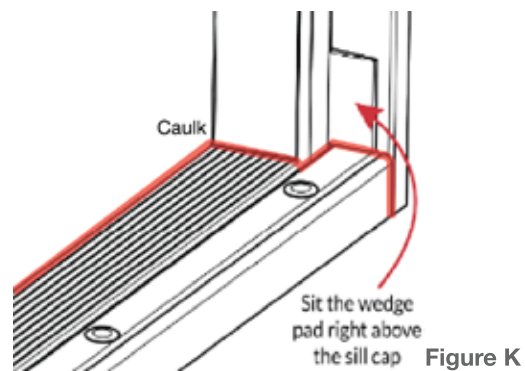
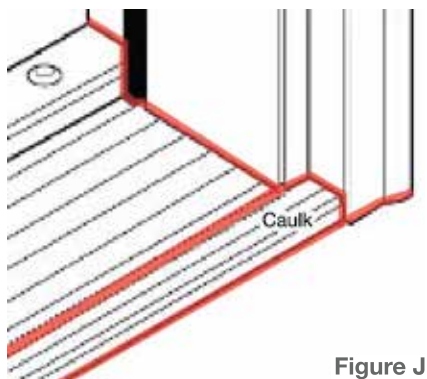
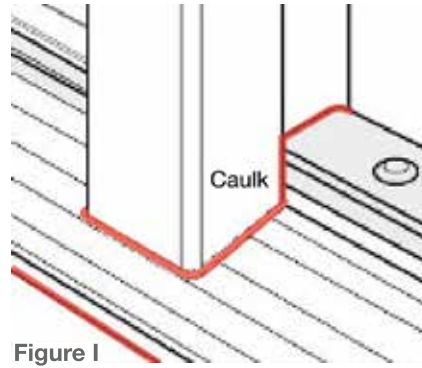
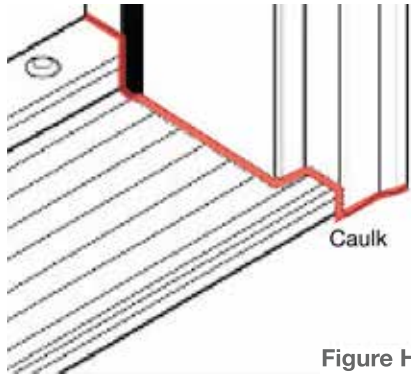

- E. Sand entire surface of the door with a #220 grit sandpaper and wipe clean with a soft cloth.
- F. Clean the door with a mild detergent solution, rinse and let dry.
- G. Use only an exterior acrylic latex paint on the exterior side of the door. the interior side can accept either an exterior or interior acrylic latex paint. Apply per the paint manufacturer's instructions.
- H. Do not paint the weatherstrip or hinges. Do not close the door until the paint is completely dry.
- I. All 6 sides of the door should be painted or sealed to prevent damage or warping. Fiberglass composite doors are to be sealed and or painted inside and out. **Do Not Leave the Inside Unfinished. Failure to finish all sides of the door will void all warranties.**

**Note: For Fiberglass Grained doors, see staining instructions for finishing doors on fiberglass door manufacturer's website. For the best finish, please follow their specific staining instructions. Leave protective sill cover or protective tape on the sill riser until construction is complete, where applicable.**

## Step 7: Install Hardware

- A. Install lock and strike plate per manufacturer's instructions.
- B. If deadbolt is desired, remove edge filler plate (most steel doors) and drill door edge and face for deadbolt per manufacturer's template.

## **ADDITIONAL INSTRUCTIONS:**

### **Door and Sidelite Installation:**

#### **Align Unit**

- A. Complete steps 1 and 2.
- B. Plumb, align, shim and secure the unit similar to steps 3 and 4. begin with the sidelight jamb nearest the door hinge jamb (step 3) then secure the remaining side jamb (step 4). Note: shim above both door jambs at the head jamb prior to securing the unit.
- C. Follow steps 5 and 6.

### **Double Door Installation:**

#### **Shim & Secure Inactive Hinge Jamb**

- A. Complete steps 1 and 2.
- B. Add shims above the head jamb from the inside to maintain proper clearances and alignment.
- C. Plumb from the outside on the inactive door side only.

#### **Shim & Secure Active Hinge Jamb**

- A. Do steps 3 C, D and E.
- B. Nail the head in place at the shim locations.
- C. Nail the head and hinge jamb brickmold.
- D. Follow steps 5 and 6.

### **Policy**

- A. All unfinished doors are subject to possible leakage around the glass, and around panels, and/or around lock openings until such time as they are properly finished in accordance with the manufacturer's directions. Failure to comply will void any warranty expressed or implied against such leakage and will not be considered a product failure.
- B. Proper installation is essential to prevent water leakage under normal conditions. Failure to properly caulk under and around any unit as per the installation instructions can cause water leakage and/or frame rot. installation Not in accordance with the manufacturer's directions will void any warranty expressed or implied against such leakage and will not be considered a product failure.
- C. All residential products are designed to be used under normal conditions. Any application which results in severe exposure should be considered a special circumstance and appropriate precautions should be taken before determining what product is best suited for a particular application. when in doubt, call for more information before proceeding.
- D. Manufacturer/Distributor reserve the right to refund the original purchase price or to repair/replace at our option any product which it deems to have failed. manufacturer/Distributor will not be responsible for incidental or consequential damage. Frame rot can be considered one form of incidental or consequential damage resulting from water leakage, whether visible or not. Consumers are advised to report any signs of leakage immediately to the installer or to the Dealer where said product was purchased.
- E. Stainable Doors are less forgiving than painted doors. An overhang that minimizes the exposure to both is recommended. If that is not possible, understand that most clear finishes applied over stain will erode in sunlight. Frequent re-coating will be required to keep from damaging the finish topcoat and/or stain. peeling can be a result of such exposure.
- F. Door and frame must be finished within 30 days of installation. Failure to comply will void any warranty expressed or implied against peeling and or warping.

**See Dyke Industries, Inc. Prehung Unit and Finish Warranty for details.**

# WARRANTY STATEMENT

## Warranty Coverage:

When sold directly by Dyke Industries, Inc. (and any of its subsidiaries), Dyke Industries, Inc.'s interior and exterior prehung door units ("Product") come with varying periods of warranty coverage (depending on chosen material) and are guaranteed to be free of defects in material and workmanship that might unreasonably affect its performance. To qualify for Warranty Coverage, the interior and/or exterior door system MUST be installed in accordance with the interior and exterior door installation guidelines and meet the required overhang requirements both referenced below in the 'Door Installation Requirements' and 'Overhang Requirements' sections.

## Door Installation Requirements:

To qualify for Warranty Coverage for any of the prehung interior or exterior units outlined in the table below, the door unit must be installed correctly by properly following the interior and exterior prehung unit installation instructions available at: <https://dykedoors.com/warranties/installationinstructions.com>. If improper installation occurs and any part of the door unit is damaged, fails to perform, comply, etc. as a result, the warranty is voided and it is not Dyke Industries, Inc.'s responsibility to replace the door unit or refund the customer.

## Coverage Periods – (Non-Transferable):

All Warranty Coverage initiates on the original date of purchase and continues for the stated duration, so long as the original purchaser continues to own and reside in the property in which the Product was installed.

**Please note, ALL WARRANTIES ARE NON-TRANSFERABLE.**

## Component Coverage:

There are multiple components required to build an interior and exterior prehung unit and each component comes with their own specific warranty. Dyke Industries, Inc. is warranting their pre-hung interior and exterior door system and any manufacturer supporting components for the durations outlined in the following table. Please visit the following link: <https://dykedoors.com/resources/warranty-information> for more detailed warranty information across many of our product manufacturers.

The coverage duration for these items is listed below:

## Door Unit and Primary Component Warranty Coverage Duration:

Product Type:	Description:	Residential:	Commercial:
Interior Prehung Unit	Molded, Wood, MDF	5 Years	N/A
Prehung Fiberglass Premium Entry System*	Smooth/Textured/Flush Glazed	Limited Lifetime	1 Year
Prehung Fiberglass Base Entry System*	Smooth & Textured	2 Years	N/A
Prehung Steel Premium Entry System*	Steel and Wood Edge	10 Years	1 Year
Prehung Steel Base Entry System*	Steel and Wood Edge	2 Years	N/A
Prehung Wood Premium Entry System	All Wood Species/Frames	1 Year	N/A
Door Glass	1" Clear, Blinds, & Deco	10 Years	1 Year
Locking System	Multi-Point Lock ONLY	10 Years	1 Year
Finish (Finish Defense ONLY) **	Paint and Stain	10 Years	N/A

## \*Qualifying Exterior Prehung Door System:

\*To qualify for the corresponding Warranty Coverage durations for the exterior entry systems listed above, both a steel and fiberglass door unit MUST be prehung on a smooth or textured composite frame with smooth or composite brickmold and smooth or composite mull posts (Premium Entry System). Any steel or fiberglass door unit prehung on a primed wood frame or FrameSaver-Type frame with primed brickmold and primed mull posts (our Base Prehung System) will only receive a prehung exterior door system warranty of two (2) years. In an exterior setting, because of wear and tear caused by weather across all climates, our prehung wood premium entry system carries a one (1) year warranty and must meet the referenced installation guidelines (above) as well as the proper overhang requirements (below).

## \*\*Prefinishing (With Finish Defense) Warranty Coverage:

Dyke Industries, Inc. (or any of its subsidiaries) will warranty our finish using Finish Defense on any painted or stained doors for a period of ten (10) years from the original date of purchase by a dealer. This warranty covers paint failure in the form of peeling with no evidence of abuse. We cannot warranty paint or stain finish chipping or scratches caused by product abuse or improper installation. Paint and stain samples may vary from the actual finish. Color fading, especially in extreme exposures (facing south or west) or climates (desert or coastal) caused by exposure to natural elements also is beyond our and the paint or stain manufacturer's control and will not be covered under our warranty. Use of a non-venting storm door also voids our prefinish warranty.

### Application:

This is the most important step in your new entry system selection process. Protecting it properly can lower maintenance, improve performance, and extend the life of your new entry system. Every exterior door requires protection and there are many factors to consider such as exposure to natural elements, color choices, storm door use and the degree of homeowner maintenance required. All these factors must be evaluated to determine your final choice. Protecting your exterior door unit is extremely important and can help lower required maintenance, improve performance, and ensure the longevity of your exterior door unit.

### Overhang Requirements (Exterior Units):

No matter the material chosen, in short, every exterior door—Entry, Patio or Double (French) Doors—should have an overhang to protect the unit from natural elements. **For all prefinished doors/units, Dyke Industries, Inc. requires the proper overhang needed to comply with our warranty coverage should extend at least four feet wider (two feet each side) than the door unit and at least five feet out from the house. In extreme exposures (facing south or west) or climates (desert or coastal) overhangs should be double that size.**

Inadequate overhang protection can lead to color fading, component damage and water related issues such as warping, wood failure or leakage. Adequate overhangs increase your choice of door types, design, colors and specifications. They also ensure years of dependable performance. Failure to abide by these overhang requirements will void your exterior prefinish warranty. Exterior door units constructed with ADA Sills void warranty coverage even with proper overhang due to required sill construction for ADA compliance which can cause potential water infiltration.

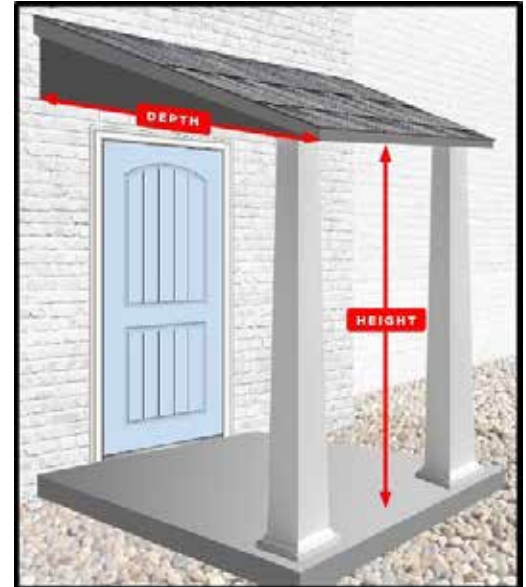

### Colors:

The face of an exterior door can exceed 120 degrees (even higher when a non-venting storm door is used) in many applications. Prolonged exposure at these temperatures can quickly deteriorate the finish and physically damage the door/door unit. Light colors reflect heat, dark colors absorb heat. Consider sun exposure and overhang protection when selecting a color for your door. Your choice of colors can directly affect your door's longevity and performance.

# WARRANTY STATEMENT

## Exclusions from Coverage:

### This warranty does not cover:

1. Door units not installed according to published unit dimensions and installation instructions (referenced above).
  - a. Exterior door units should not be installed in a direct weather exposure or without a proper overhang. An ideal overhang must extend at least four feet wider (two feet each side) than the door unit and at least five feet out from the house. Failure to adhere to these overhang and directional requirements will void any warranty coverage. See 'Overhang Requirements' from Dyke Industries, Inc. (above).
  - b. Prefinished Exterior Door units where a non-venting storm door is used
2. Defects or damages arising out of shipment by common carriers, private transportation, or other means of transportation.
3. Defects or damages arising out of improper handling or cleaning, normal wear and tear, defective or improper installation, improper overhang requirements, defective or improper glazing, accident, act of God, intentional human act, misuse or abuse, or any other circumstances beyond the control of Dyke Industries, Inc.
4. Warp not exceeding 1/4" in the plane of the door panel, bow or misalignment in the door frame in which the door panel is hung.
5. Products installed in high-moisture environments, such as swimming pool enclosures or greenhouses.
6. Product used or installed in non-residential environments, including but not limited to, retail or commercial applications.
7. Exterior door units constructed with ADA Sills void warranty coverage even with proper overhang due to required sill construction for ADA compliance which can cause potential water infiltration.
8. Products not finished/painted in accordance with installation instructions.
9. Products finished/painted a dark color with prolonged exposure to direct sunlight.
10. Product finished with non-recommended paints or topcoats.
11. Performance of finish paints and stains.
12. Labor, shipping, or other charges incurred or claimed by the Customer.
13. Use of chemical-based cleaners on a prefinished unit.
14. Failure to provide an adequate overhang for exterior doors, damage caused by extreme temperature buildup where storm doors are present (1b).
15. Fading, discoloration or color change of the Finish that equals or is less than 5 Delta E units as calculated in accordance with industry standard ASTM E 308E 805-81 and ASTM D 2244-85. This is effective on the date of product manufactured. Color change will be measured on an exposed color surface of the door slab that has been properly maintained and installed and follows our overhang requirements as per the recommendation as noted above.
16. Labor charges for removing, installing, replacing, or re-finishing any Dyke Industries Entry and Patio Door, or any other materials.

### **Warranty Claim Procedures:**

If within the applicable warranty period, the Customer discovers a defect in the Product which is covered by this warranty, the Customer must follow this procedure:

1. The Customer must promptly present a written claim to Dyke Industries, Inc. 309 Center Street, Little Rock, AR 72201 – Attn: Warranty Claim Department. Dyke Industries, Inc. must receive this claim no later than ten (10) days after the potential defect was discovered on the primed or prefinished entry door system after the date of the Customer's purchase.
2. The Customer must use reasonable diligence to include in the written claim all the following:
  - a. Adequate description of defect(s).
  - b. Identification of Product design or pattern.
  - c. Exact Product size.
  - d. Date and location of the Customer's original purchase and the date of delivery to the Customer.
3. The Customer, at Dyke Industries Inc.'s option, must permit Dyke Industries, Inc., or its representative (dealer customer or 3rd party assigned by Dyke Industries, Inc.) to inspect the Product. Failure to allow for inspection by either Dyke Industries, Inc., or its representative (dealer customer or 3rd party assigned by Dyke Industries, Inc.) will void any warranty claim.

### **Remedies:**

After receiving a valid claim, Dyke Industries, Inc. will, at its option, (a) repair the Product, (b) provide a replacement Product (or part, as appropriate) of like kind and design or (c) issue a refund. If option (c), refund will be for purchase price of the door slab/door unit ONLY.

### **Disclaimer of Warranty:**

DYKE INDUSTRIES, INC. MAKES NO IMPLIED WARRANTY, INCLUDING WARRANTIES OF MERCHANTABILITY OR FITNESS FOR A PARTICULAR PURPOSE, WITH RESPECT TO THE PRODUCT (OR ANY REPLACEMENT), AND MAKES NO OTHER WARRANTIES, EXPRESS OR IMPLIED, STATUTORY OR OTHERWISE, WITH RESPECT TO THE PRODUCT (OR ANY REPLACEMENT), EXCEPT TO THE EXTENT PROVIDED HEREIN.

### **Limitation of Remedies:**

THE REMEDIES SET FORTH ABOVE ARE THE CUSTOMER'S EXCLUSIVE REMEDIES FOR BREACH OF WARRANTY. IN NO CASE SHALL DYKE INDUSTRIES, INC. BE LIABLE TO THE CUSTOMER OR ANY OTHER PERSON FOR ANY GENERAL, INCIDENTAL OR CONSEQUENTIAL DAMAGES. SOME STATES DO NOT PERMIT ANY LIMITATION ON THE LENGTH OF AN IMPLIED WARRANTY, OR ANY EXCLUSION OR LIMITATION OF INCIDENTAL OR CONSEQUENTIAL DAMAGES, AND THEREFORE SOME LIMITATION OR EXCLUSIONS IN THIS WARRANTY MAY NOT APPLY.

Unless modified in a later writing signed by both Dyke Industries, Inc. and the claimant, this warranty is the complete and exclusive warranty relating to the Product, superseding all earlier agreements and other communications relating to the Product. No employee of Dyke Industries, Inc. or any other party is authorized to make any warranty in addition to this warranty. Invalidation of any one or more of the provisions of this warranty shall not invalidate or affect any one of the other provisions hereof, which shall remain in full force and effect.

This warranty is not transferable. This warranty provides specific legal rights, and other rights, which vary from state to state, may be available.

# STEEL 90 MIN



Steel 90 minute flush panel

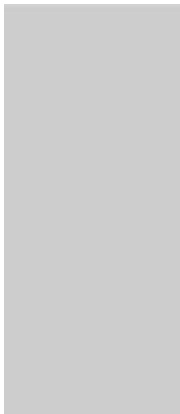

SEFFR

Door	2'6"	2'8"	2'10"	3'0"	3'6"
6'8"	●	●	●	●	●



SE361PFR

Door	2'8"	2'10"	3'0"
6'8"	●	●	●



SE6PFR

Door	2'8"	2'10"	3'0"
6'8"	●	●	●

● Available    🔥 90 minute Fire Rated Available

Broken pallet charges may apply on special orders.

# ADJUSTABLE SPLIT STEEL FRAMES

## Entry Fit™ K2A-Series Pre-Finished Adjustable Double Rabbet Steel Door Frames for Interior and Exterior Application



- Main jambs 18 gauge, Closure Trim 22 gauge
- 6 Wall sizes 4" to 9 1/2", 1" adjustment each. *Larger wall sizes available upon request.*
- Manufactured of corrosion resistant galvanized steel
- Anchoring holes & nail clearance slots for wood casing
- 4" Hinge Prep with 5/8" radius.
- 2-3/4" Adjustable T-strike prep with 2-3/4" deadbolt prep
- Allows units to be site delivered pre-assembled with door
- Standard IDP Inc. threshold prep at no charge

### Colors And Finishes

#### STANDARD COLORS



IDP White

IDP Brown

Satin Black

#### OPTIONAL COLORS



Sky White

Mesa Tan

Pale Brown

Light Gray

Primer Gray

Alumasteel

#### SPECIAL ORDER COLORS



Window White

Satin White

Bright Matte White

Polar White

New Bone White

RAL 1013

Matte Cream

Sandstone

Beige



Interstate Blue



Teal



Patina Green



RAL 6005



Hartford Green



RAL 7006



Toffee



Chestnut Brown



Window Bronze



New Dark Bronze



Redwood



Burgundy



RAL 7038



RAL 7045



Slate Gray



Gloss Black



Satin Black



Matte Black

# COMMERCIAL DOORS



# MASONRY INTERIOR/EXTERIOR

## STEP 1 CHOOSE YOUR FRAME

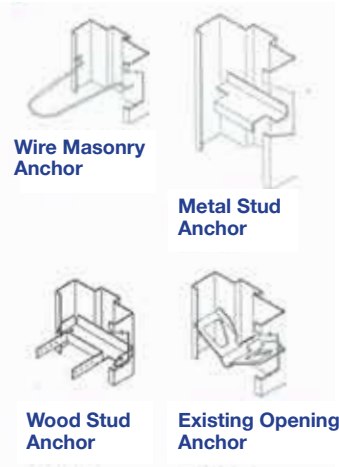

### Hollow Metal 5-3/4" Standard\* Frame

Includes:

- 16 gauge - primed galvalneal
- Reinforced for closer
- Prepped and reinforced for 3 - 4-1/2" square corner hinges and 4-7/8" ASA strike prep
- Fire-rated Warnock Hersey mylar fire labels
- Assembled welded or knock down
- Handed for left or right swing (Must specify - inswing or outswing)
- Anchors (must specify)
- Prepped for 3 rubber silencers
- Will work with block walls, poured walls, metal studs or wood studs for new construction and/or existing construction

Other sizes and profiles available special order  
\*Standard Frame - Interior and exterior application

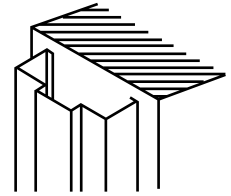

Standard Application  
(Interior and Exterior Applications)

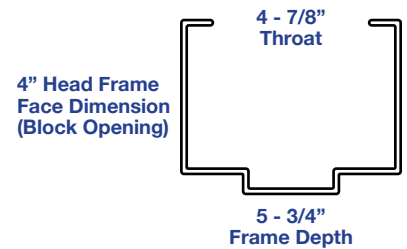
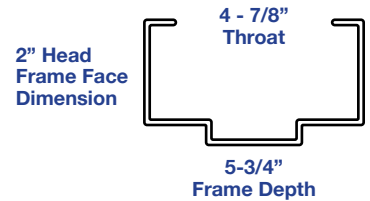

# DRYWALL INTERIOR

## STEP 1 CHOOSE YOUR FRAME

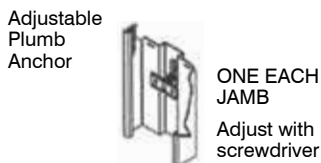

### Hollow Metal DRYWALL\*\* FRAME

Includes:

- 16 gauge- cold rolled-primed galvalneal
- Prepped and reinforced for 3 - 4-1/2" square corner hinges and 4-7/8" ASA strike prep
- Fire-rated Warnock Hersey mylar fire labels
- Integral adjustable plumb anchor
- 4 tab interlocking systems
- Knock down, ready to install
- Handed for left or right swing (must specify)
- Prepped for 3 rubber silencers

Other sizes and profiles available special order  
\*\* Drywall Frame - Interior application only

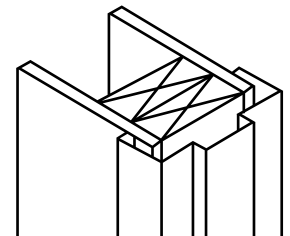

Drywall Application  
(Interior Applications Only)

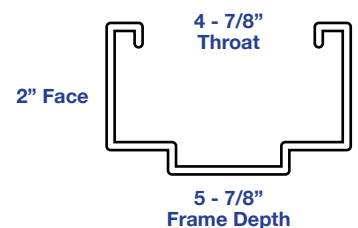

# STEP 2 CHOOSE YOUR FRAME & DOOR

## 1 Expandable Drywall Frame

Includes:

- 16 gauge - A40 paintable galvalneal steel
- Prepped with 3 - 4-1/2" high frequency, square corner hinge reinforcements and 4-7/8" ASA strike prep
- Rubber silencer holes (3 @ strike jambs & 2 @ double heads)
- Mechanical K.D. corner connection
- All double heads undersized by 1/8" from normal width
- Non handed / Reversible
- #7 x 2-1/2" screws included (6 per jamb, 4 per head)
- Face punched & dimpled for wall anchoring
- 4" to 9 1/2", 1" adjustment each

Other sizes and profiles available special order

\*\*Interior and exterior application

### 8 - 3/4" Expandable Jamb



### 13 - 1/4" Expandable Jamb

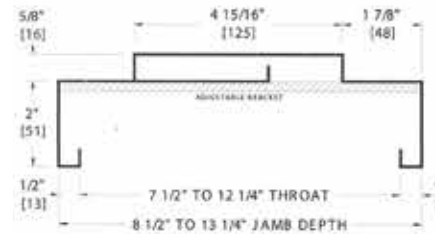

### Rough Opening



### Corner Detail

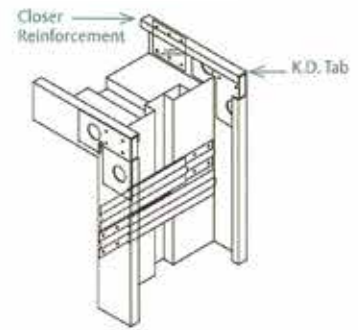

## 2 Steel Door Profiles

Includes:

- 18 gauge - primed galvalneal
- Reinforced for closer
- Prepped for 3 - 4-1/2" square corner hinges
- Fire-rated Warnock Hersey mylar fire labels
- Available with 161 cylindrical lock prep
- 86 edge prep (mortise) or rim panic reinforcement (exit device) available by special order
- Screwed in top cap
- Inverted channel with top cap welded flush

Special order sizes available



**Flush Steel Door**  
20 - 40 x 68, 70 & 80  
*Some sizes special order*



**Vision Lite Flush**  
10 x 10 Exposed  
Flush Steel Door



**Narrow Lite**  
4 x 25, 6 x 30  
Flush Steel Door



**Bottom Louver**  
24 x 12  
24 x 24  
18 x 12  
12 x 12  
Flush Steel Door

# STEP 3 CHOOSE YOUR HARDWARE

## 1 Hang the Door



**Ball Bearing Hinge**  
4 - 1/2" x 4 - 1/2"  
MPB79 26D



**NRP Ball Bearing Hinge**  
4 - 1/2" x 4 - 1/2"  
MPB79-NRP 26D  
MPB91-NRP 32D



**Spring Hinge**  
4 - 1/2" x 4 - 1/2"  
MPS60 26D

## 2 Secure the door with Lock, Flush Bolts, Panic Bars, etc.



**Key In Lever Cylindrical Lock**  
Augusta Design  
626 Satin Chrome  
4600LN Series



**Passage**  
4601LN (FLASHship#885089)  
*Both levers always active*



**Privacy**  
4602LN (FLASHship#885091)  
*Outside lever locked by inside push button. Inside lever always active. Unlocked by turning inside lever or emergency key.*



**Storeroom**  
4605LN (FLASHship#885094)  
*Outside lever always locked. Inside lever always active.*



**Entry**  
4607LN (FLASHship#885099)  
*Outside lever locked by inside push button. Unlocked by turning inside lever or key in exterior. Inside lever always active. If button is pushed and turned 90°, outside lever will remain locked*



**Single Cylinder Deadbolt**  
D212 (FLASHship#885134)  
*Key by Thumbturn.*



**Standard Traffic Vertical Rod Exit Device**  
2110-36 - Non Rated (FLASHship# 885152)  
2110F-36 - Fire Rated (FLASHship# 885154)  
630 Satin Stainless Steel  
Special Order



**Standard Traffic Rim Exit Device**  
2100-36 - Non Rated (FLASHship# 885148)  
2100F-36 - Fire Rated (FLASHship# 885150)  
630 Satin Stainless Steel



**Lever with Escutcheon Exterior Exit Device Trim**  
AU426F LHR- Left Hand Reverse  
AU426F RHR - Right Hand Reverse  
630 Satin Stainless Steel  
Special Order



**Rim Cylinder Use with Escutcheon Trim**  
1109 x 6 - Pin  
626 Satin Chrome  
Special Order



**Key In Lever Exterior Exit Device Trim**  
AU446F - Keyed  
626 Satin Chrome  
AAU441F - Nightlatch Access by Key  
AU446F - Classroom  
626 Satin Chrome

# STEP 3 CHOOSE YOUR HARDWARE

## 3 Control the Door with Closers - Grade 1



**Standard Traffic Door Closer**  
 1101BF - Non-Hold Open (FLASHship #885227)  
 1111BF - Hold Open (FLASHship #885228)  
 689 Aluminum Painted



**Heavy Traffic Door Closer**  
 2701 - Non-Hold Open (FLASHship #885191)  
 2711 - Hold Open Includes Cover (FLASHship #885192)  
 689 Aluminum Painted



Parallel Arm Mount



Top Jamb Arm Mount



Regular Arm Mount

Closer includes hardware pack for regular arm, top jamb mounting, and parallel arm installation.

## 4 Protect the Door with Push & Pull Plates, Kickplates, etc.



**Latch Protector**  
 320CL  
 32D  
 (FLASHship# 885784)



**Push Plate**  
 4" x 16"  
 70C32D  
 (FLASHship# 885892)



**Pull Plate**  
 4" x 16"  
 106 x 70C 32D  
 (FLASHship# 885750)



**Steel Door Flush Bolt**  
 555  
 US26D  
 (FLASHship# 885855)



**Kick Plate**  
 8" x 34"  
 KP50 32D  
 (FLASHship# 885755)

**Dome Floor Stop**  
 441H  
 US26D  
 (FLASHship# 885804)



**Concave Wall Bumper**  
 409  
 US32D  
 (FLASHship# 885798)



**Convex Wall Bumper**  
 406  
 US32D  
 (FLASHship# 885792)



**Door Viewer**  
 622  
 US26D  
 190° 9/16" hole  
 (FLASHship# 885877)



**Kick Down Door Holder**  
 460  
 26D  
 (FLASHship# 885820)



## 5 Seal the Door with Weatherstrip, Sweep and Threshold



**Weatherstrip/Smoke Seal Adhesive Back**  
 S88D



**Weatherstrip Perimeter Gasket**  
 303AV



**Door Sweep**  
 315CN



**Brush Weatherstrip**  
 18061CNB

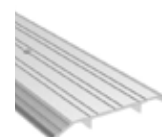

**Threshold**  
 ADA Compliant  
 1/2" x 5" x 3 ft., 4 ft. & 6 ft.  
 171A

# SPECIFICATIONS

## EXTERIOR DOOR SIZES

6/8 SINGLE UNIT

Door Size	Unit Dimension	Rough Opening	Masonry Opening
2-0 x 6-8	25-1/2 x 81-3/4	26 x 82-1/4	28 x 83
2-6 x 6-8	31-1/2 x 81-3/4	32 x 82-1/4	34 x 83
2-8 x 6-8	33-1/2 x 81-3/4	34 x 82-1/4	36 x 83
2-10 x 6-8	35-1/2 x 81-3/4	36 x 82-1/4	38 x 83
3-0 x 6-8	37-1/2 x 81-3/4	38 x 82-1/4	40 x 83

7/0 SINGLE UNIT

Door Size	Unit Dimension	Rough Opening	Masonry Opening
2-0 x 7-0	25-1/2 x 85-3/4	26 x 86-1/4	28 x 87
2-6 x 7-0	31-1/2 x 85-3/4	32 x 86-1/4	34 x 87
2-8 x 7-0	33-1/2 x 85-3/4	34 x 86-1/4	36 x 87
2-10 x 7-0	35-1/2 x 85-3/4	36 x 86-1/4	38 x 87
3-0 x 7-0	37-1/2 x 85-3/4	38 x 86-1/4	40 x 87

8/0 SINGLE UNIT

Door Size	Unit Dimension	Rough Opening	Masonry Opening
2-0 x 8-0	25-1/2 x 97-3/4	26 x 98-1/4	28 x 99
2-6 x 8-0	31-1/2 x 97-3/4	32 x 98-1/4	34 x 99
2-8 x 8-0	33-1/2 x 97-3/4	34 x 98-1/4	36 x 99
2-10 x 8-0	35-1/2 x 97-3/4	36 x 98-1/4	38 x 99
3-0 x 8-0	37-1/2 x 97-3/4	38 x 98-1/4	40 x 99

6/8 SINGLE  
W/1 SIDE LITE

Door Size	Unit Dimension	Rough Opening	Masonry Opening
3-0 x 6-8 x 1-0	51 x 81-3/4	51-1/2 x 82-1/4	53-1/2 x 83
3-0 x 6-8 x 1-2	53 x 81-3/4	53-1/2 x 82-1/4	55-1/2 x 83

7/0 SINGLE  
W/1 SIDE LITE

Door Size	Unit Dimension	Rough Opening	Masonry Opening
3-0 x 7-0 x 0-10	49 x 85-3/4	49-1/2 x 86-1/4	51-1/2 x 87
3-0 x 7-0 x 1-0	51 x 85-3/4	51-1/2 x 86-1/4	53-1/2 x 87
3-0 x 7-0 x 1-2	53 x 85-3/4	53-1/2 x 86-1/4	55-1/2 x 87

8/0 SINGLE  
W/1 SIDE LITE

Door Size	Unit Dimension	Rough Opening	Masonry Opening
3-0 x 8-0 x 1-0	51 x 97-3/4	51-1/2 x 98-1/4	53-1/2 x 99
3-0 x 8-0 x 1-2	53 x 97-3/4	53-1/2 x 98-1/4	55-1/2 x 99

6/8 DOUBLE UNIT

Door Size	Unit Dimension	Rough Opening	Masonry Opening
4-0 x 6-8	50 x 81-3/4	50-1/2 x 82-1/4	52-1/2 x 83
5-0 x 6-8	62 x 81-3/4	62-1/2 x 82-1/4	64-1/2 x 83
5-4 x 6-8	66 x 81-3/4	66-1/2 x 82-1/4	68-1/2 x 83
6-0 x 6-8	74 x 81-3/4	74-1/2 x 82-1/4	76-1/2 x 83

7/0 DOUBLE UNIT

Door Size	Unit Dimension	Rough Opening	Masonry Opening
4-0 x 7-0	50 x 85-3/4	50-1/2 x 86-1/4	52-1/2 x 87
5-0 x 7-0	62 x 85-3/4	62-1/2 x 86-1/4	64-1/2 x 87
5-4 x 7-0	66 x 85-3/4	66-1/2 x 86-1/4	68-1/2 x 87
6-0 x 7-0	74 x 85-3/4	74-1/2 x 86-1/4	76-1/2 x 87

8/0 DOUBLE UNIT

Door Size	Unit Dimension	Rough Opening	Masonry Opening
4-0 x 8-0	50 x 97-3/4	50-1/2 x 98-1/4	52-1/2 x 99
5-0 x 8-0	62 x 97-3/4	62-1/2 x 98-1/4	64-1/2 x 99
5-4 x 8-0	66 x 97-3/4	66-1/2 x 98-1/4	68-1/2 x 99
6-0 x 8-0	74 x 97-3/4	74-1/2 x 98-1/4	76-1/2 x 99

6/8 SINGLE  
W/2 SIDE LITES

Door Size	Unit Dimension	Rough Opening	Masonry Opening
0-10 x 3068 x 0-10	60-1/2 x 81-3/4	61 x 82-1/4	63 x 83
1-0 x 3068 x 1-0	64-1/2 x 81-3/4	65 x 82-1/4	67 x 83
1-2 x 3068 x 1-2	68-1/2 x 81-3/4	69 x 82-1/4	71 x 83

7/0 SINGLE  
W/2 SIDE LITES

Door Size	Unit Dimension	Rough Opening	Masonry Opening
0-10 x 3070 x 0-10	60-1/2 x 85-3/4	61 x 86-1/4	63 x 87
1-0 x 3070 x 1-0	64-1/2 x 85-3/4	65 x 86-1/4	67 x 87
1-2 x 3070 x 1-2	68-1/2 x 85-3/4	69 x 86-1/4	71 x 87

8/0 SINGLE  
W/2 SIDE LITES

Door Size	Unit Dimension	Rough Opening	Masonry Opening
0-10 x 3080 x 0-10	60-1/2 x 97-3/4	61 x 98-1/4	63 x 99
1-0 x 3080 x 1-0	64-1/2 x 97-3/4	65 x 98-1/4	67 x 99
1-2 x 3080 x 1-2	68-1/2 x 97-3/4	69 x 98-1/4	71 x 99

**6/8 DOUBLE  
DOOR PATIO**

Door Size	Unit Dimension	Rough Opening	Masonry Opening
5-0 x 6-8	63 x 81-3/4	63-1/2 x 82-1/4	65-1/2 x 83
5-4 x 6-8	67 x 81-3/4	67-1/2 x 82-1/4	69-1/2 x 83
6-0 x 6-8	75 x 81-3/4	75-1/2 x 82-1/4	77-1/2 x 83

**7/0 DOUBLE  
DOOR PATIO**

Door Size	Unit Dimension	Rough Opening	Masonry Opening
5-0 x 7-0	63 x 85-3/4	63-1/2 x 86-1/4	65-1/2 x 87
5-4 x 7-0	67 x 85-3/4	67-1/2 x 86-1/4	69-1/2 x 87
6-0 x 7-0	75 x 85-3/4	75-1/2 x 86-1/4	77-1/2 x 87

**8/0 DOUBLE  
DOOR PATIO**

Door Size	Unit Dimension	Rough Opening	Masonry Opening
5-0 x 8-0	63 x 97-3/4	63-1/2 x 98-1/4	65-1/2 x 99
5-4 x 8-0	67 x 97-3/4	67-1/2 x 98-1/4	69-1/2 x 99
6-0 x 8-0	75 x 97-3/4	75-1/2 x 98-1/4	77-1/2 x 99

**6/8 TRIPLE  
DOOR PATIO**

Door Size	Unit Dimension	Rough Opening	Masonry Opening
7-6 x 6-8	94-1/2 x 81-3/4	95 x 82-1/4	97 x 83
8-0 x 6-8	100-1/2 x 81-3/4	101 x 82-1/4	103 x 83
9-0 x 6-8	112-1/2 x 81-3/4	113 x 82-1/4	115 x 83

**7/0 TRIPLE  
DOOR PATIO**

Door Size	Unit Dimension	Rough Opening	Masonry Opening
7-6 x 7-0	94-1/2 x 85-3/4	95 x 86-1/4	97 x 87
8-0 x 7-0	100-1/2 x 85-3/4	101 x 86-1/4	103 x 87
9-0 x 7-0	112-1/2 x 85-3/4	113 x 86-1/4	115 x 87

**8/0 TRIPLE  
DOOR PATIO**

Door Size	Unit Dimension	Rough Opening	Masonry Opening
7-6 x 8-0	94-1/2 x 97-3/4	95 x 98-1/4	97 x 99
8-0 x 8-0	100-1/2 x 97-3/4	101 x 98-1/4	103 x 99
9-0 x 8-0	112-1/2 x 97-3/4	113 x 98-1/4	115 x 99

**HINGE AND BORE LOCATIONS FROM TOP OF DOOR**

6/8 and 7/0		8/0	
<b>Top Hinge</b>	6 1/2" to top of hinge	<b>Top Hinge</b>	6-1/2" to top of hinge
<b>Mid Hinge</b>	37 1/2" to top of hinge	<b>2<sup>nd</sup> Hinge</b>	32 1/2" to top of hinge
<b>Bottom Hinge</b>	68 1/2" to top of hinge	<b>3<sup>rd</sup> Hinge</b>	58 1/2" to top of hinge
<b>Lock Bore</b>	45 7/8" to center of bore	<b>4<sup>th</sup> Hinge</b>	84-1/2" to top of hinge
<b>Dead Bolt Bore</b>	40 3/8" to center of bore	<b>Lock Bore</b>	60" to center of bore
		<b>Dead Bolt Bore</b>	54-1/2" to center of bore

**RETRO SIZES**

Unit	Unit Dimension
Patio 5/0 x 6/8	59-1/2 x 79-3/4
Double 5/0 x 6/8	59 x 79-3/4
Patio 6/0 x 6/8	71-1/2 x 79-3/4
Double 6/0x 6/8	71 x 79-3/4

**IDP Split Metal Frame R/O's**

3/0 6/8 ADA = 37-1/4" x 80-1/2"
3/0 6/8 ADJ = 37-1/4" x 81-1/4"
3/0 7/0 ADA = 37-1/4" x 84-1/2"
3/0 7/0 ADJ = 37-1/4" x 85-1/4"
3/0 8/0 ADA = 37-1/4" x 96-1/2"
3/0 8/0 ADJ = 37-1/4" x 97-1/4"

All split metal frames are given as rough opening only. Contact your sales rep for other dimensions as needed.

**MISCELLANEOUS**

<b>DEDUCT</b>	<b>SLAB SIZE</b>
Outswing units deduct 3/4" from height	2-0 x 6-8 23-3/4 x 79
ADA sill units deduct 7/8" from height	2-6 x 6-8 29-3/4 x 79
	2-8 x 6-8 31-3/4 x 79
<b>ADD</b>	3-0 x 6-8 35-3/4 x 79
10" transoms add 11-1/2" to height	
12" transoms add 13-1/2" to height	
<b>Standard peep height:</b> 21" measured top down	<b>ADA peep height:</b> 36" measured top down



June 2025

# COMMERCIAL OPENING SOLUTIONS

Our production team can prep, install, and customize solutions for us in homes, businesses and institutions. Our offerings include doors, frames, hardware and locks.

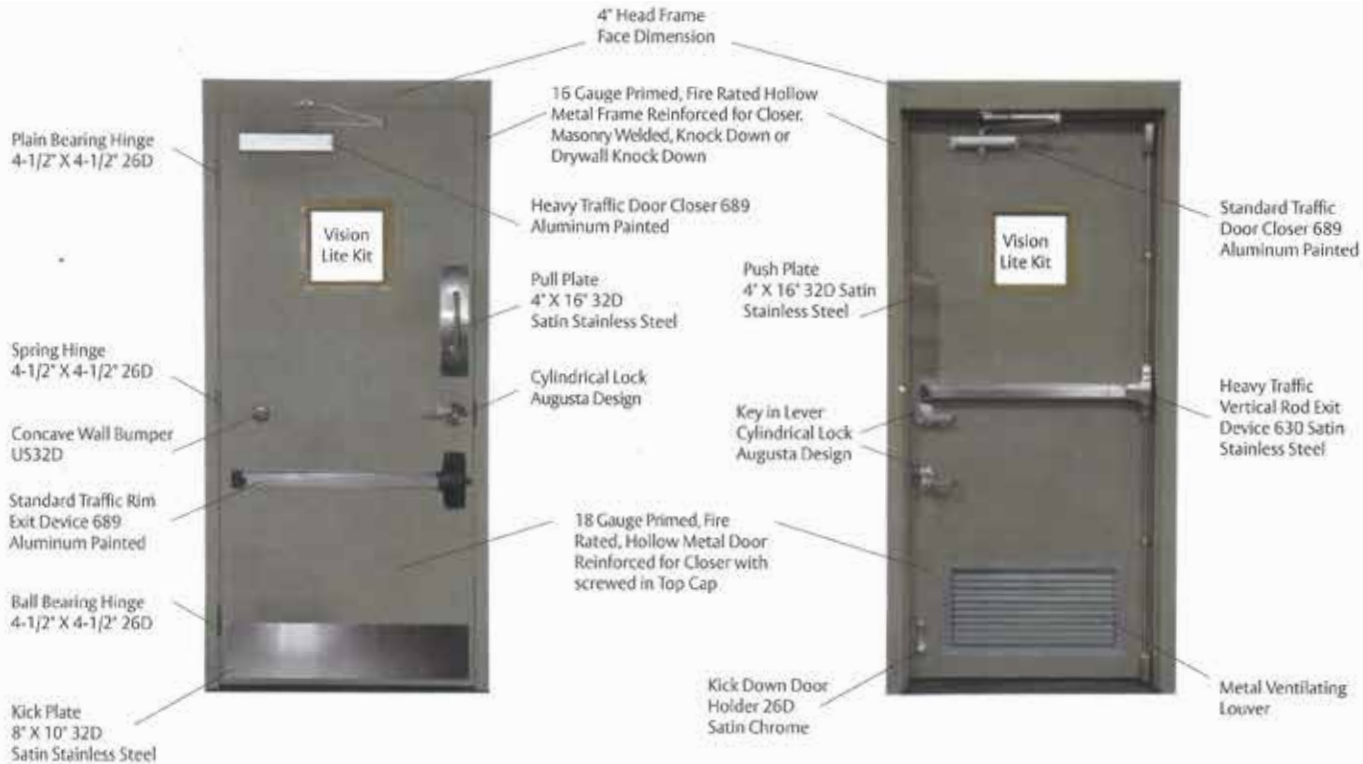





The environment and Dyke Industries have been partners for over 150 years. We are committed to recycling material because it's good for today and tomorrow. The commitment to be sustainable and responsible isn't new to Dyke Industries. We want to provide long-lasting and energy efficient doors that last well into the future.





 **Dyke Industries, Inc.**

 **plastpro**

**Dyke Industries Inc. - Cincinnati**

1360 Harrison Brookville Rd.

West Harrison, IN 47060

**859-341-5500**

[cincinnati.dykedoors.com](http://cincinnati.dykedoors.com)

***Serving the Building Industry Since 1866***

DYEG.CIN.09250